

Light efficiency:



Output: 580 lm

Light quality:



Peak: 12601 cd

Power: 10.8 W

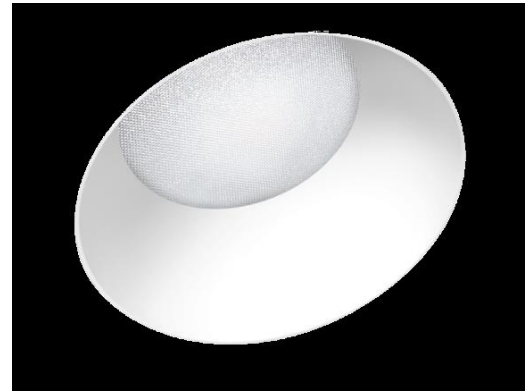

Beam angle

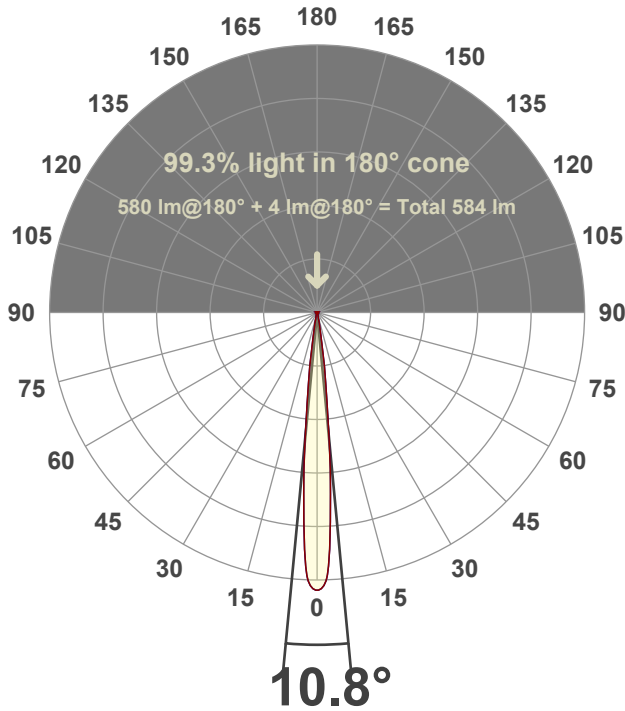

Test number:

CR3D-RF-DR-C10-30K-10

Luminaire Model:

Core 3" Round Deep Regress C10-30K-10°

Date and time:

4/6/2026 3:58:54 PM

LUM: 580



*Variation due to source size, bezel geometry, or secondary optics

Spectra

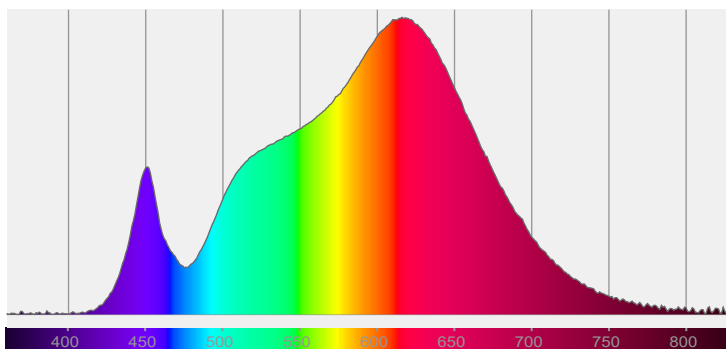

CRI: 92.3 (R1-R8)

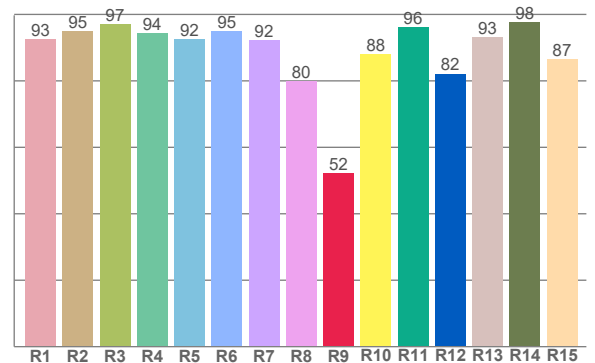

Color parameters

	Color rendering index	Red component	Color fidelity	Color gamut	Color quality scale	Color coordinate cie 1931	Color coordinate cie 1931	Color coordinate	Color coordinate	Color deviation from black body
	CRI	CRI R9	TM30 R _f	TM30 R _g	CQS	x	y	u	v	Δuv
	92.3	52.3	91.9	100.1	90.7	0.437	0.408	0.249	0.349	0.0013

R_f 91.9
Fidelity index R_f

R_g 100.1
Gammut index R_g

TM30: 91.9

TM-30Color

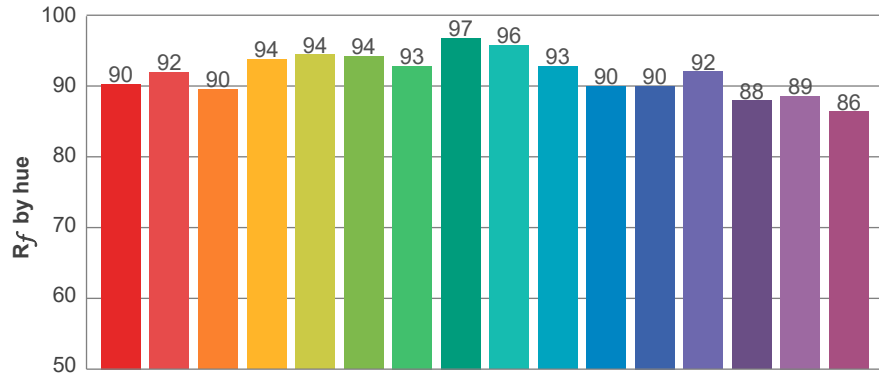

Hue Bin	R_f	Graphic shifts (%)	
		Chroma	Hue
1	90	-5%	-1%
2	92	-4%	3%
3	90	-1%	5%
4	94	1%	4%
5	94	1%	3%
6	94	3%	0%
7	93	0%	-4%
8	97	1%	-2%
9	96	-2%	0%
10	93	-3%	3%
11	90	0%	7%
12	90	4%	2%
13	92	4%	-4%
14	88	4%	-9%
15	89	0%	-8%
16	86	-2%	-11%

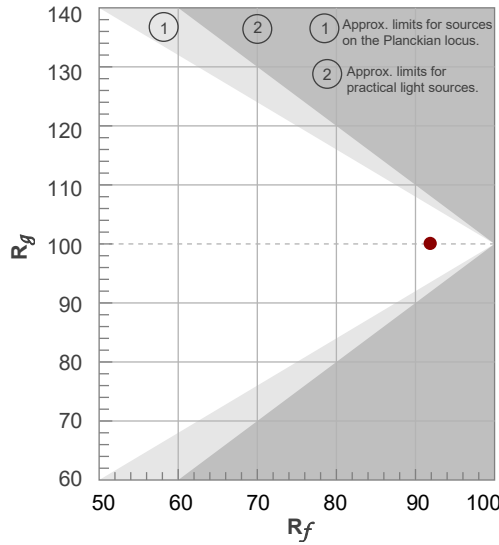

Color vector graphics

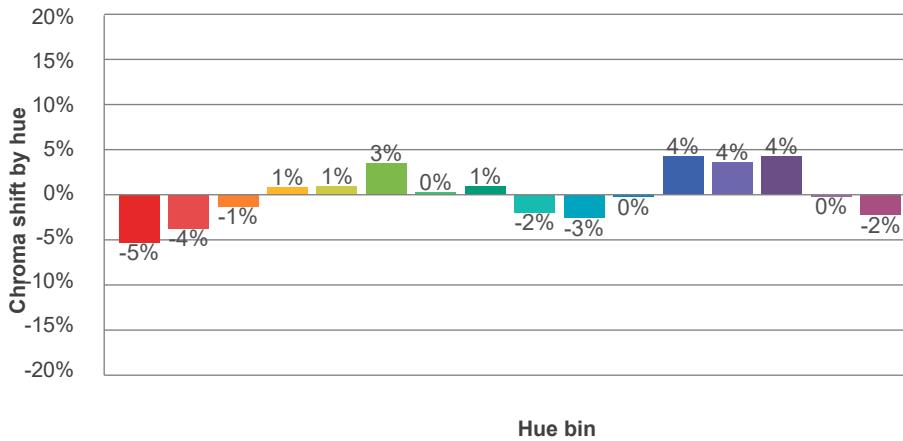
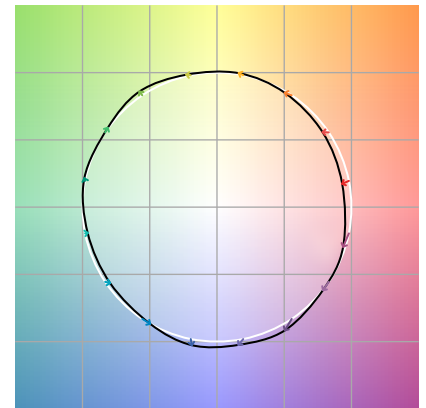

Color distortion

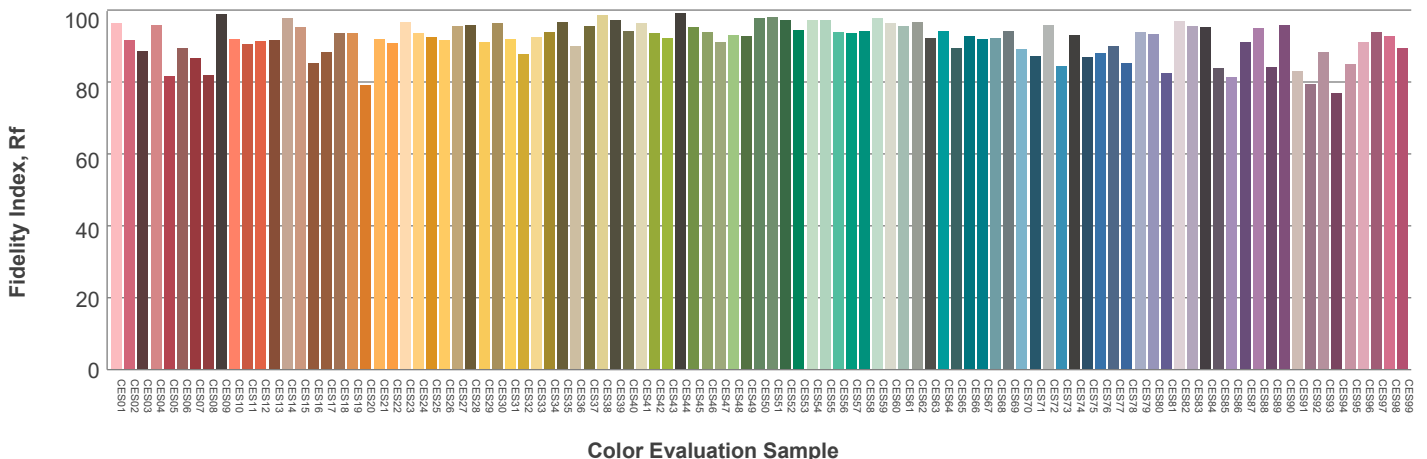

Beam details

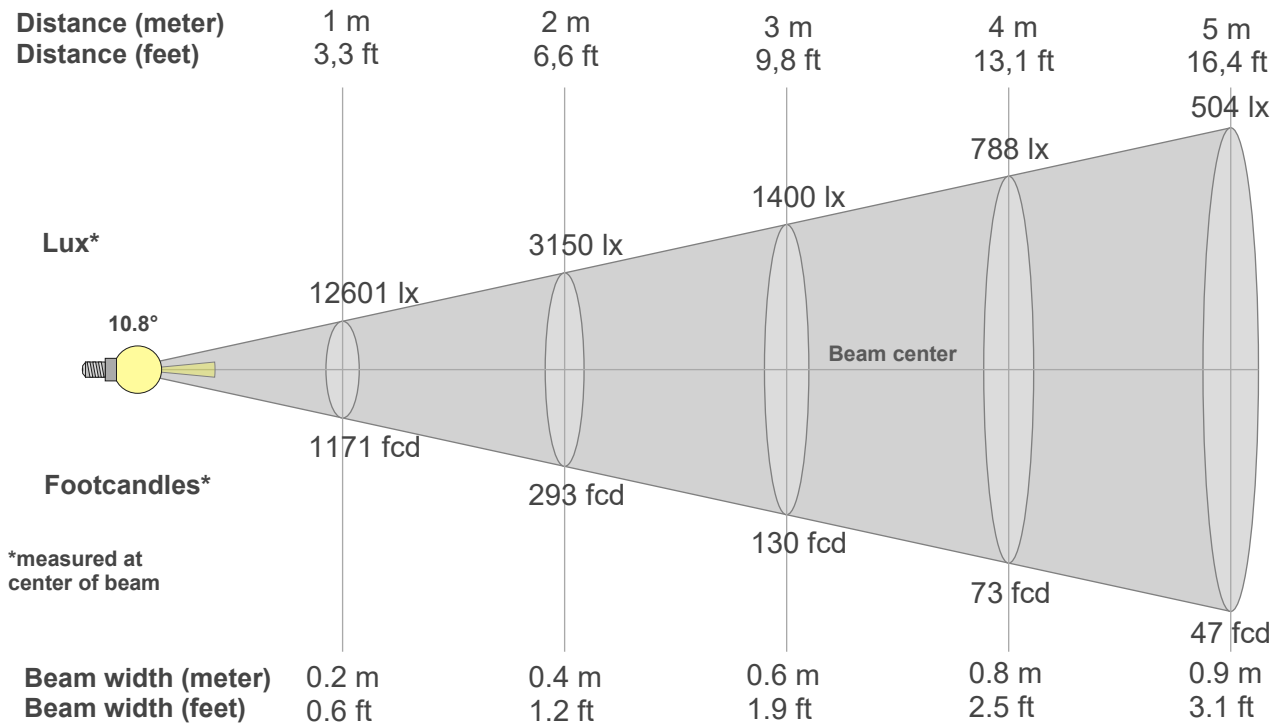

Beam intensities from 1-20m

1m	2m	3m	4m	5m	6m	7m	8m	9m	10m	11m	12m	13m	14m	15m	16m	17m	18m	19m	20m
3.3ft	6.6ft	9.8ft	13.1ft	16.4ft	19.7ft	23ft	26.2ft	29.5ft	32.8ft	36.1ft	39.4ft	42.7ft	45.9ft	49.2ft	52.5ft	55.8ft	59.1ft	62.3ft	65.6ft
12601lx	3150lx	1400lx	788lx	504lx	350lx	257lx	197lx	156lx	126lx	104lx	88lx	75lx	64lx	56lx	49lx	44lx	39lx	35lx	32lx
1170.7fcd	292.7fcd	130.1fcd	73.2fcd	46.8fcd	32.5fcd	23.9fcd	18.3fcd	14.5fcd	11.7fcd	9.7fcd	8.1fcd	6.9fcd	6fcd	5.2fcd	4.6fcd	4.1fcd	3.6fcd	3.2fcd	2.9fcd

Intensities in 0° c-plane

0°	1°	2°	3°	4°	5°	6°	7°	8°	9°	10°	11°	12°	13°	14°	15°	16°	17°	18°	19°
12.6k	12.6k	12.6k	10.9k	9.0k	7.1k	5.2k	3.3k	2.4k	1.4k	0.9k	0.6k	0.4k	0.3k	0.2k	0.2k	0.2k	0.1k	0.1k	0.1k
100%	100%	100%	86%	71%	56%	41%	26%	19%	11%	7%	5%	3%	2%	2%	1%	1%	1%	1%	1%

Intensities in 90° c-plane

0°	1°	2°	3°	4°	5°	6°	7°	8°	9°	10°	11°	12°	13°	14°	15°	16°	17°	18°	19°
12.6k	12.6k	12.6k	10.9k	9.0k	7.1k	5.2k	3.3k	2.4k	1.4k	0.9k	0.6k	0.4k	0.3k	0.2k	0.2k	0.2k	0.1k	0.1k	0.1k
100%	100%	100%	86%	71%	56%	41%	26%	19%	11%	7%	5%	3%	2%	2%	1%	1%	1%	1%	1%

Intensities in 180° c-plane

0°	1°	2°	3°	4°	5°	6°	7°	8°	9°	10°	11°	12°	13°	14°	15°	16°	17°	18°	19°
12.6k	12.6k	12.6k	10.9k	9.0k	7.1k	5.2k	3.3k	2.4k	1.4k	0.9k	0.6k	0.4k	0.3k	0.2k	0.2k	0.2k	0.1k	0.1k	0.1k
100%	100%	100%	86%	71%	56%	41%	26%	19%	11%	7%	5%	3%	2%	2%	1%	1%	1%	1%	1%

Intensities in 270° c-plane

0°	1°	2°	3°	4°	5°	6°	7°	8°	9°	10°	11°	12°	13°	14°	15°	16°	17°	18°	19°
12.6k	12.6k	12.6k	10.9k	9.0k	7.1k	5.2k	3.3k	2.4k	1.4k	0.9k	0.6k	0.4k	0.3k	0.2k	0.2k	0.2k	0.1k	0.1k	0.1k
100%	100%	100%	86%	71%	56%	41%	26%	19%	11%	7%	5%	3%	2%	2%	1%	1%	1%	1%	1%

Beam angle 50%	Field angle 10%	Cutoff angle 2,5%	Intensity ratio in 120° cone	Intensity ratio in 90° cone
10.8°	18.3°	25.1°	98.6%	97.0%

LAMPS (number of lamps)
50

Light planning Luminaire budgetary diagram

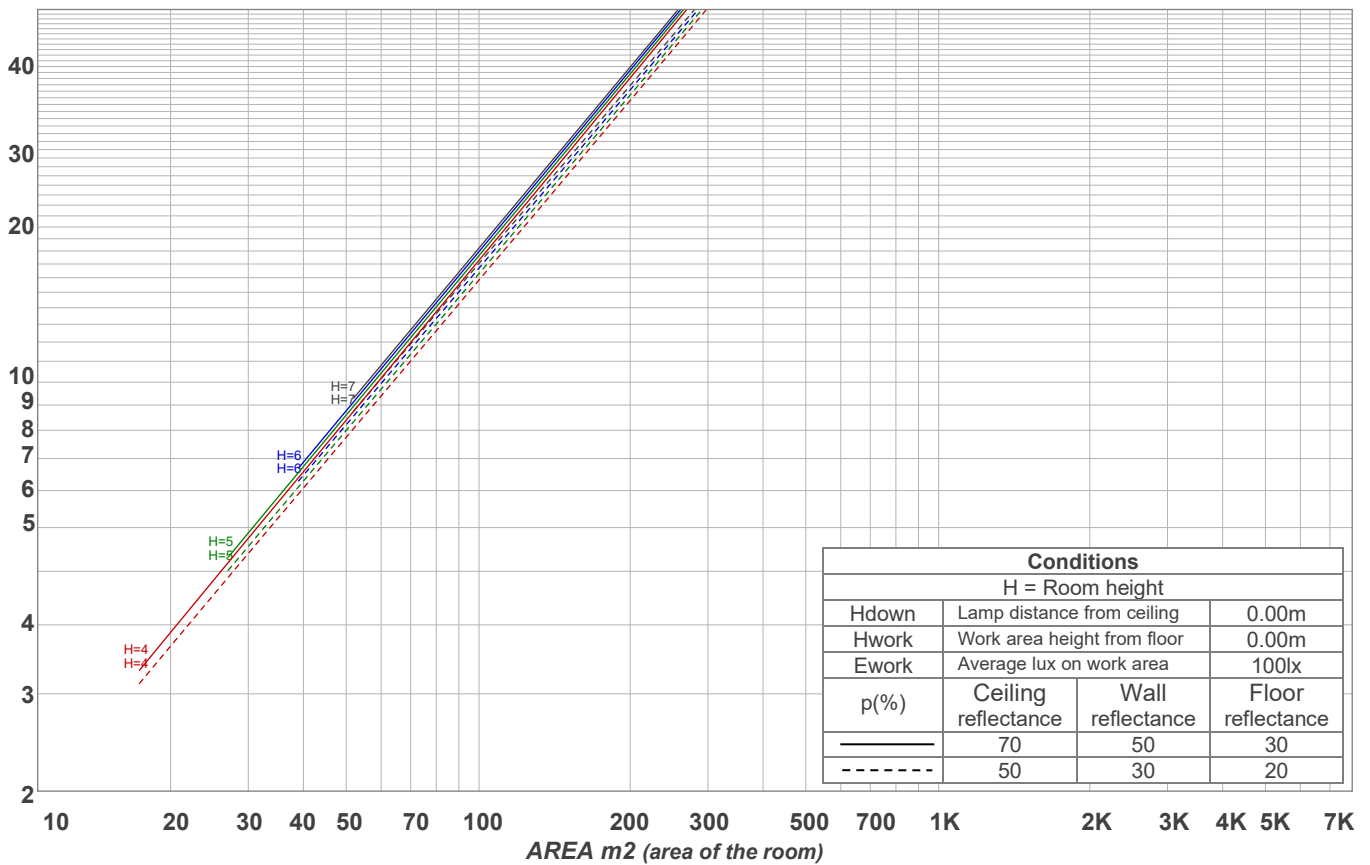

Luminaire budgetary diagram AREA m2 (area of the room) Coefficients of Utilization

Ceiling reflectance	80				70				50			30			10			0			
Wall reflectance	70	50	30	10	70	50	30	10	50	30	10	50	30	10	50	30	10	50	30	10	0
Floor reflectance	20	20	20	20	20	20	20	20	20	20	20	20	20	20	20	20	20	20	20	20	0
RCR	(RCR: Room Cavity Ratio)																				
	Room Values are expressed as percentage of Lumens delivered to the task surface																				
0	119	119	119	119	116	116	116	116	111	111	111	106	106	106	102	102	102	100	100	100	
1	116	114	112	110	113	112	110	109	108	106	105	104	103	102	101	100	99	98	98	98	
2	113	109	107	105	111	108	106	104	105	103	101	102	101	99	99	98	97	96	96	96	
3	110	106	103	101	108	105	102	100	102	100	98	100	98	97	98	97	96	94	94	94	
4	108	103	100	98	106	102	99	97	100	98	96	99	97	95	97	95	94	93	93	93	
5	106	101	98	95	104	100	97	95	99	96	94	97	95	93	96	94	93	92	92	92	
6	104	99	96	93	103	98	95	93	97	95	93	96	94	92	95	93	92	91	91	91	
7	102	97	94	92	101	97	94	92	96	93	91	95	93	91	94	92	90	90	90	90	
8	101	96	93	91	100	95	92	90	95	92	90	94	91	90	93	91	90	89	89	89	
9	99	94	92	90	99	94	91	89	93	91	89	93	91	89	92	90	89	88	88	88	
10	98	93	90	89	98	93	90	88	92	90	88	92	90	88	91	89	88	87	87	87	

Zonal Lumen Summary

0°-10°	10°-20°	20°-30°	30°-40°	40°-50°	50°-60°	60°-70°	70°-80°	80°-90°
441 lm	65.1 lm	31.5 lm	18.4 lm	11.4 lm	4.58 lm	2.95 lm	2.48 lm	2.64 lm
90°-100°	100°-110°	110°-120°	120°-130°	130°-140°	140°-150°	150°-160°	160°-170°	170°-180°
0.000 lm	0.000 lm	0.000 lm	0.000 lm	0.000 lm	0.000 lm	0.000 lm	0.000 lm	0.000 lm