

Light efficiency:

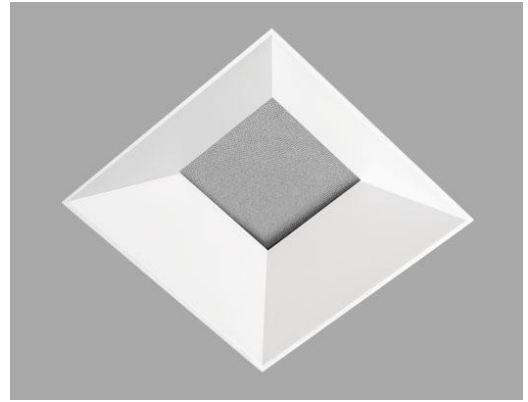

Output: 580 lm



Light quality:



Peak: 13684 cd

Power: 10.8 W

Beam angle

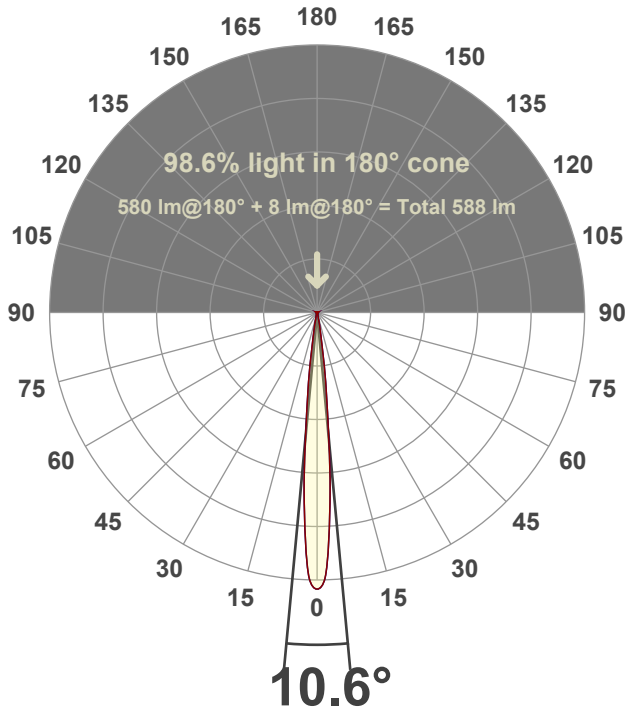

Test number:

CR3D-SA-DR-C10-30K-10

Luminaire Model:

Core 3" Square Deep Regress C10-30K-10°

Date and time:

4/6/2026 12:21:00 PM

LUM: 580



\*Variation due to source size, bezel geometry, or secondary optics

Spectra

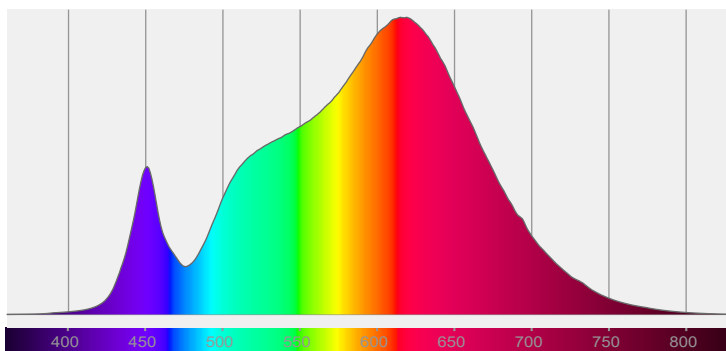

CRI: 92.1 (R1-R8)

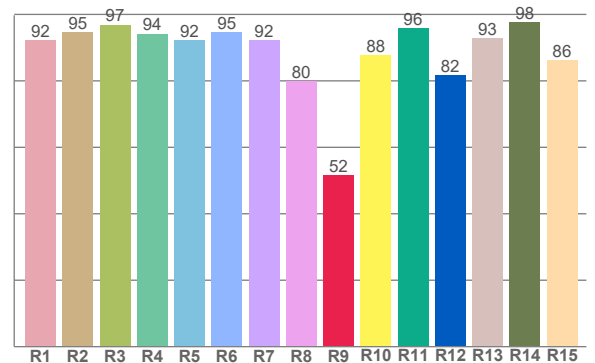

Color parameters

	Color rendering index	Red component	Color fidelity	Color gamut	Color quality scale	Color coordinate cie 1931	Color coordinate cie 1931	Color coordinate	Color coordinate	Color deviation from black body
	CRI	CRI R9	TM30 R <sub>f</sub>	TM30 R <sub>g</sub>	CQS	x	y	u	v	Δuv
	92.1	51.7	91.8	99.9	90.7	0.437	0.408	0.249	0.349	0.0015

**$R_f$  91.8**  
Fidelity index  $R_f$

**$R_g$  99.9**  
Gammut index  $R_g$

TM30: 91.8

TM-30Color

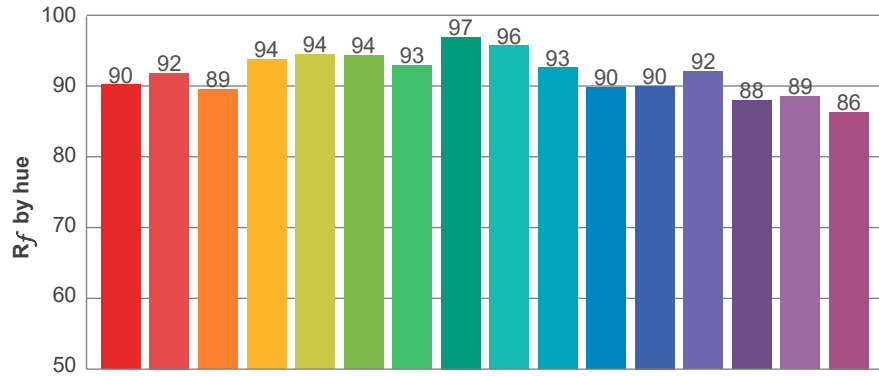

Hue Bin	$R_f$	Graphic shifts (%)	
		Chroma	Hue
1	90	-5%	-1%
2	92	-4%	3%
3	89	-1%	5%
4	94	1%	4%
5	94	1%	3%
6	94	3%	0%
7	93	0%	-4%
8	97	1%	-2%
9	96	-2%	0%
10	93	-3%	3%
11	90	0%	7%
12	90	4%	2%
13	92	4%	-4%
14	88	4%	-9%
15	89	0%	-8%
16	86	-2%	-11%

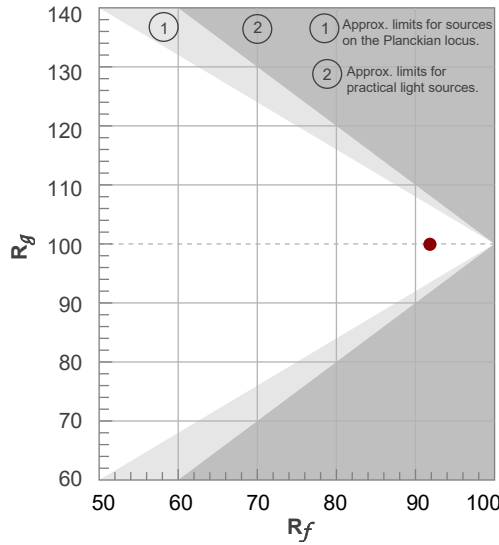

Color vector graphics

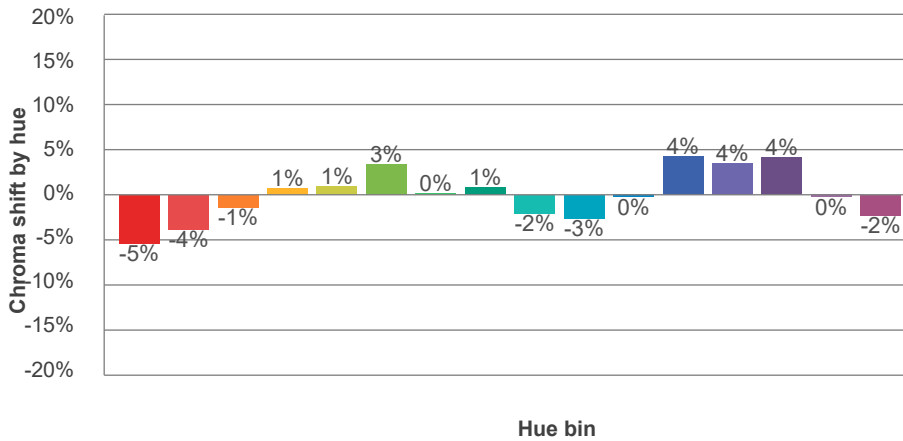
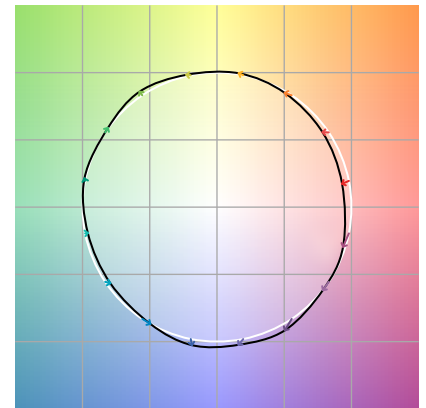

Color distortion

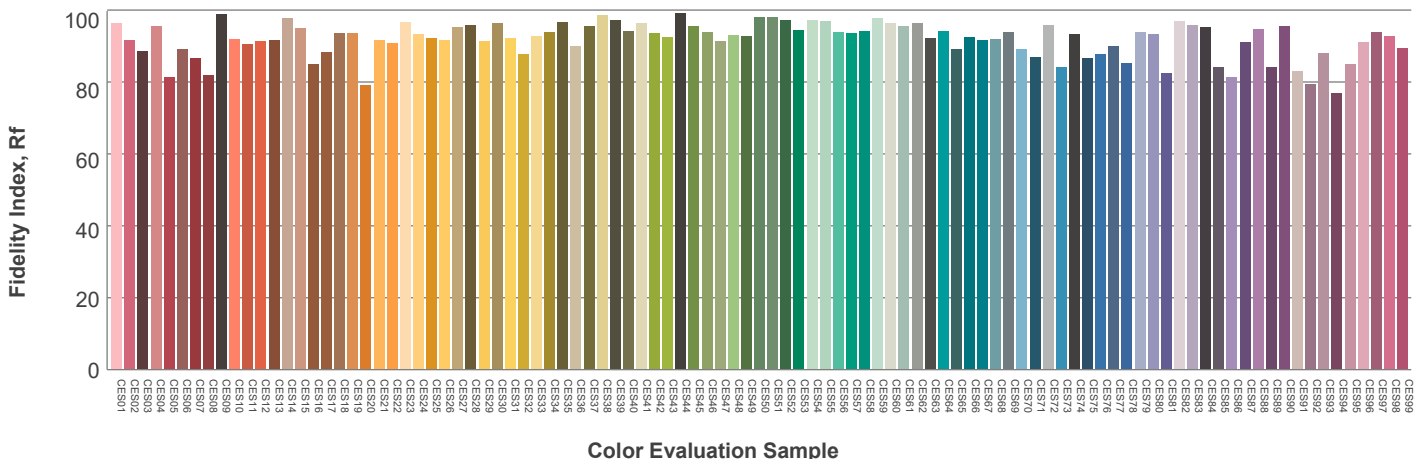

### Beam details

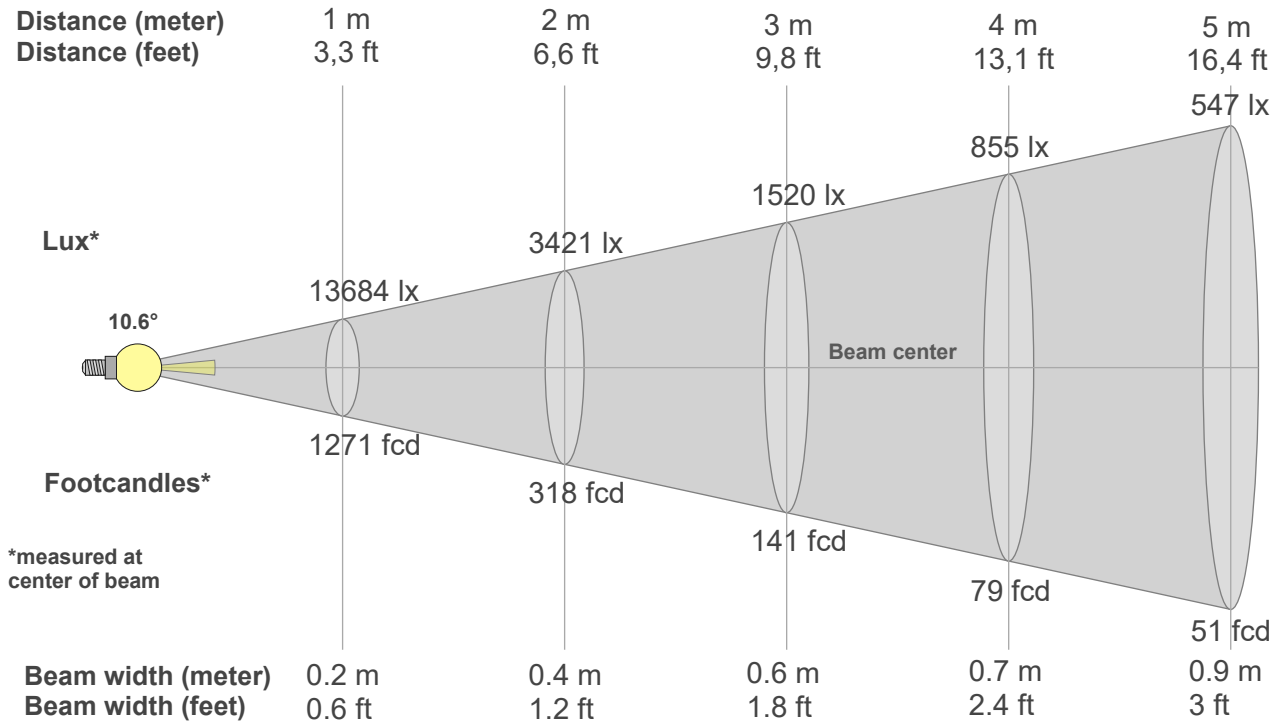

#### Beam intensities from 1-20m

1m	2m	3m	4m	5m	6m	7m	8m	9m	10m	11m	12m	13m	14m	15m	16m	17m	18m	19m	20m
3.3ft	6.6ft	9.8ft	13.1ft	16.4ft	19.7ft	23ft	26.2ft	29.5ft	32.8ft	36.1ft	39.4ft	42.7ft	45.9ft	49.2ft	52.5ft	55.8ft	59.1ft	62.3ft	65.6ft
13684lx	3421lx	1520lx	855lx	547lx	380lx	279lx	214lx	169lx	137lx	113lx	95lx	81lx	70lx	61lx	53lx	47lx	42lx	38lx	34lx
1271.3fcd	317.8fcd	141.3fcd	79.5fcd	50.9fcd	35.3fcd	25.9fcd	19.9fcd	15.7fcd	12.7fcd	10.5fcd	8.8fcd	7.5fcd	6.5fcd	5.7fcd	5fcd	4.4fcd	3.9fcd	3.5fcd	3.2fcd

#### Intensities in 0° c-plane

0°	1°	2°	3°	4°	5°	6°	7°	8°	9°	10°	11°	12°	13°	14°	15°	16°	17°	18°	19°
13.7k	13.7k	13.1k	11.3k	9.5k	7.5k	5.4k	3.7k	2.5k	1.4k	1.0k	0.6k	0.4k	0.3k	0.2k	0.2k	0.2k	0.1k	0.1k	0.1k
100%	100%	96%	83%	69%	55%	39%	27%	18%	10%	7%	5%	3%	2%	2%	1%	1%	1%	1%	1%

#### Intensities in 90° c-plane

0°	1°	2°	3°	4°	5°	6°	7°	8°	9°	10°	11°	12°	13°	14°	15°	16°	17°	18°	19°
13.7k	13.7k	13.1k	11.3k	9.5k	7.5k	5.4k	3.7k	2.5k	1.4k	1.0k	0.6k	0.4k	0.3k	0.2k	0.2k	0.2k	0.1k	0.1k	0.1k
100%	100%	96%	83%	69%	55%	39%	27%	18%	10%	7%	5%	3%	2%	2%	1%	1%	1%	1%	1%

#### Intensities in 180° c-plane

0°	1°	2°	3°	4°	5°	6°	7°	8°	9°	10°	11°	12°	13°	14°	15°	16°	17°	18°	19°
13.7k	13.7k	13.1k	11.3k	9.5k	7.5k	5.4k	3.7k	2.5k	1.4k	1.0k	0.6k	0.4k	0.3k	0.2k	0.2k	0.2k	0.1k	0.1k	0.1k
100%	100%	96%	83%	69%	55%	39%	27%	18%	10%	7%	5%	3%	2%	2%	1%	1%	1%	1%	1%

#### Intensities in 270° c-plane

0°	1°	2°	3°	4°	5°	6°	7°	8°	9°	10°	11°	12°	13°	14°	15°	16°	17°	18°	19°
13.7k	13.7k	13.1k	11.3k	9.5k	7.5k	5.4k	3.7k	2.5k	1.4k	1.0k	0.6k	0.4k	0.3k	0.2k	0.2k	0.2k	0.1k	0.1k	0.1k
100%	100%	96%	83%	69%	55%	39%	27%	18%	10%	7%	5%	3%	2%	2%	1%	1%	1%	1%	1%

Beam angle 50%	Field angle 10%	Cutoff angle 2,5%	Intensity ratio in 120° cone	Intensity ratio in 90° cone
10.6°	18°	25°	98.8%	98.3%

LAMPS (number of lamps)  
50

### Light planning Luminaire budgetary diagram

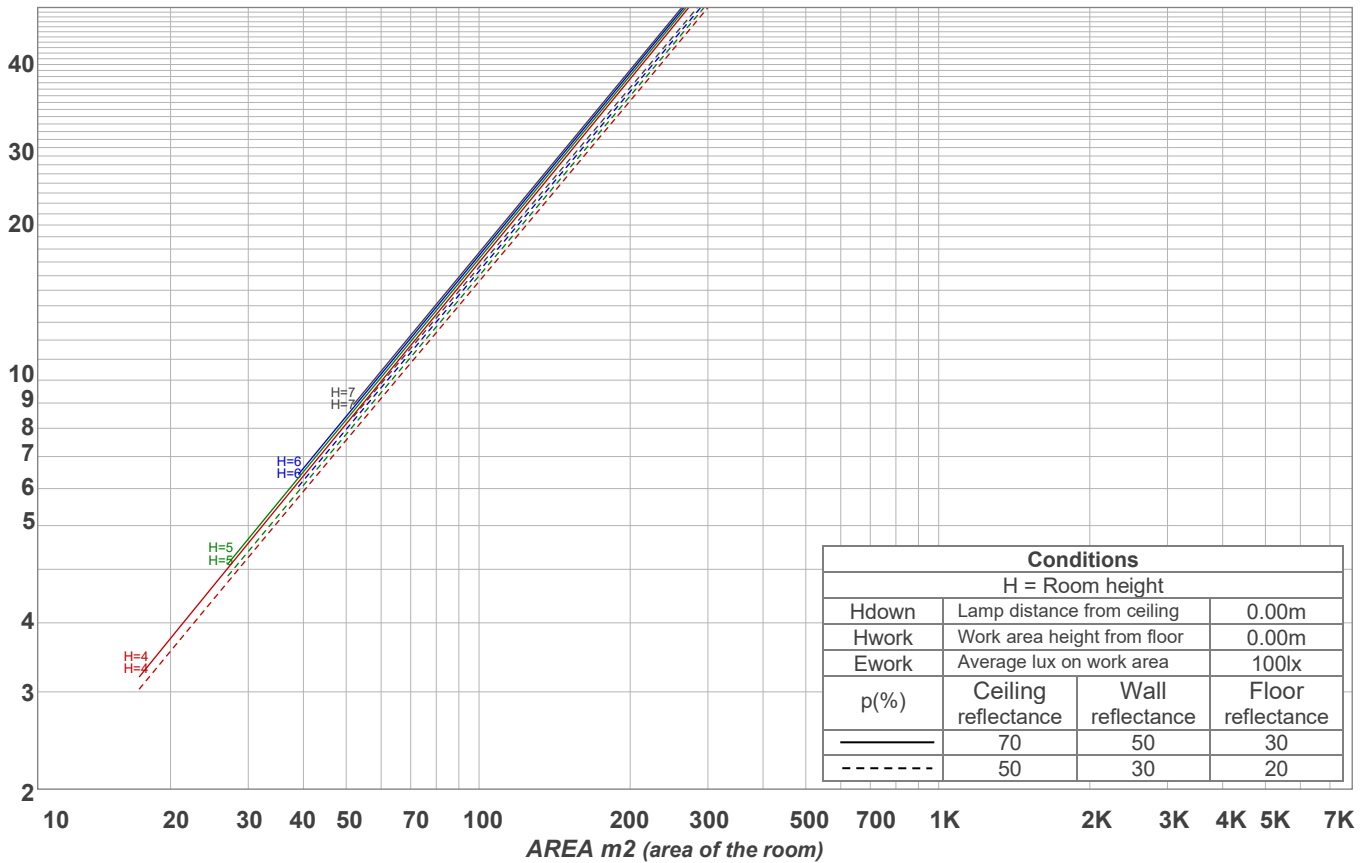

### Luminaire budgetary diagram AREA m2 (area of the room) Coefficients of Utilization

Ceiling reflectance	80				70				50			30			10			0			
Wall reflectance	70	50	30	10	70	50	30	10	50	30	10	50	30	10	50	30	10	50	30	10	0
Floor reflectance	20	20	20	20	20	20	20	20	20	20	20	20	20	20	20	20	20	20	20	20	0
RCR	(RCR: Room Cavity Ratio)																				
	Room Values are expressed as percentage of Lumens delivered to the task surface																				
0	119	119	119	119	116	116	116	116	111	111	111	106	106	106	102	102	102	100	100	100	
1	116	114	112	111	113	112	111	109	108	107	106	104	104	103	101	100	100	98	98	98	
2	113	110	108	106	111	109	106	105	106	104	102	103	101	100	99	99	98	97	97	97	
3	111	107	104	102	109	106	103	101	104	102	100	101	100	98	99	98	97	96	96	96	
4	109	105	102	100	107	104	101	99	102	100	98	100	98	97	99	97	96	95	95	95	
5	107	103	100	98	106	102	99	97	100	98	96	99	97	96	98	96	95	94	94	94	
6	105	101	98	96	104	100	98	96	99	97	95	98	96	95	97	95	94	93	93	93	
7	104	100	97	95	103	99	96	94	98	96	94	97	95	94	96	94	93	92	92	92	
8	103	98	95	94	102	98	95	93	97	95	93	96	94	93	96	94	92	91	91	91	
9	102	97	94	93	101	97	94	93	96	94	92	96	93	92	95	93	92	91	91	91	
10	101	96	94	92	100	96	93	92	95	93	92	95	93	91	94	92	91	91	91	91	

### Zonal Lumen Summary

0°-10°	10°-20°	20°-30°	30°-40°	40°-50°	50°-60°	60°-70°	70°-80°	80°-90°
468 lm	63.7 lm	23.7 lm	12.5 lm	3.67 lm	1.66 lm	2.00 lm	2.34 lm	2.83 lm
90°-100°	100°-110°	110°-120°	120°-130°	130°-140°	140°-150°	150°-160°	160°-170°	170°-180°
0.000 lm	0.000 lm	0.000 lm	0.000 lm	0.000 lm	0.000 lm	0.000 lm	0.000 lm	0.000 lm