

Light efficiency:



Output: 3513 lm

Light quality:



Peak: 12636 cd

Power: 37.8 W



Beam angle

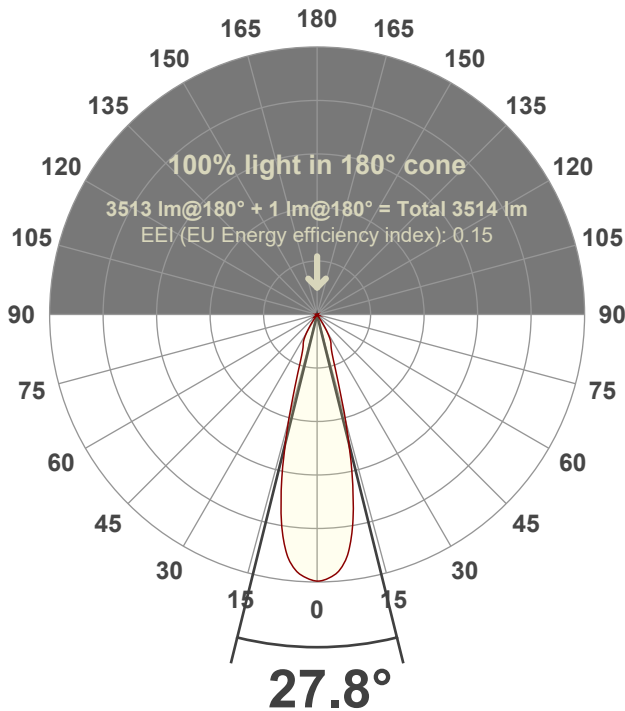

Test number:

MSC-H-L-C32-30k-28°

Luminaire Model:

Mosaic Large Accent Head-C32-30k-28°

Date and time:

8/29/2022 3:58:35 PM

LUM: 3513

Spectra

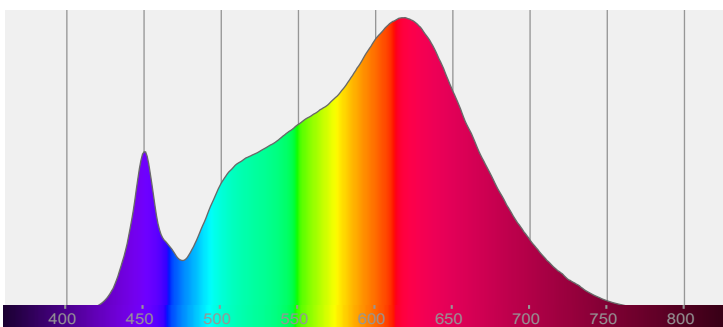

CRI: 93.6 (R1-R8)

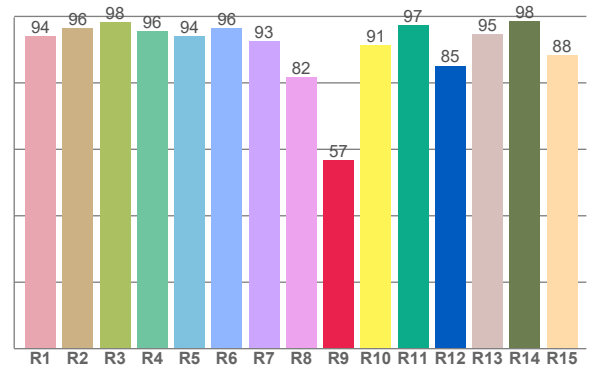

Color parameters

	Color rendering index	Red component	Color fidelity	Color gamut	Color quality scale	Color coordinate cie 1931	Color coordinate cie 1931	Color coordinate	Color coordinate	Color deviation from black body
	CRI	CRI R9	TM30 R _f	TM30 R _g	CQS	x	y	u	v	Δuv
	93.6	56.6	93.0	99.7	92.1	0.432	0.405	0.247	0.347	0.0013

R_f 93.0
Fidelity index R_f

R_g 99.7
Gammut index R_g

TM30: 93.0

TM-30Color

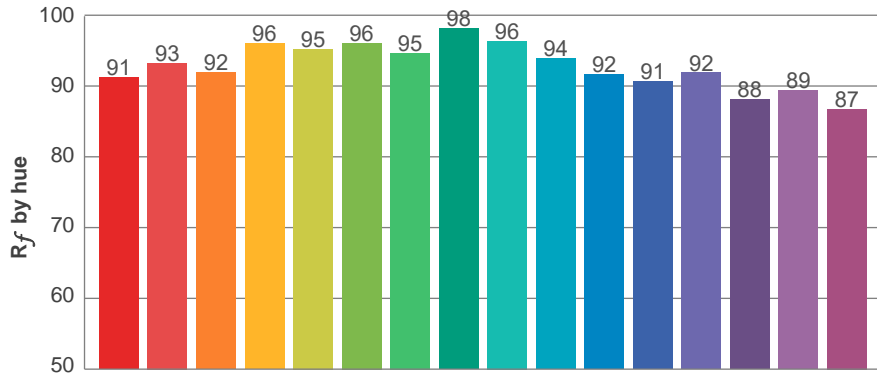

Hue Bin	R_f	Graphic shifts (%)	
		Chroma	Hue
1	91	-5%	-1%
2	93	-3%	2%
3	92	-1%	4%
4	96	0%	2%
5	95	-1%	2%
6	96	2%	0%
7	95	-1%	-2%
8	98	1%	0%
9	96	-1%	1%
10	94	-1%	3%
11	92	1%	5%
12	91	5%	-1%
13	92	3%	-5%
14	88	3%	-9%
15	89	-1%	-7%
16	87	-2%	-10%

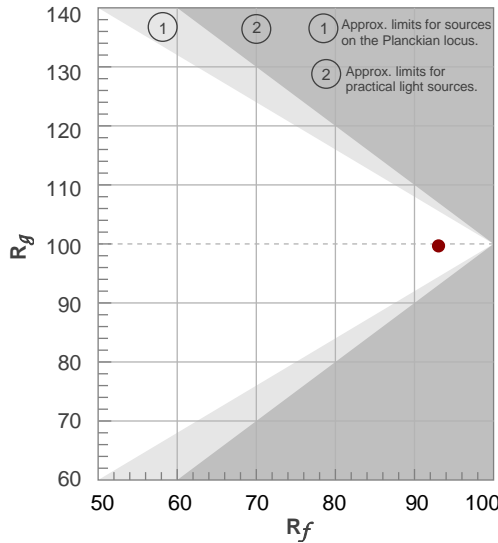

Color vector graphics

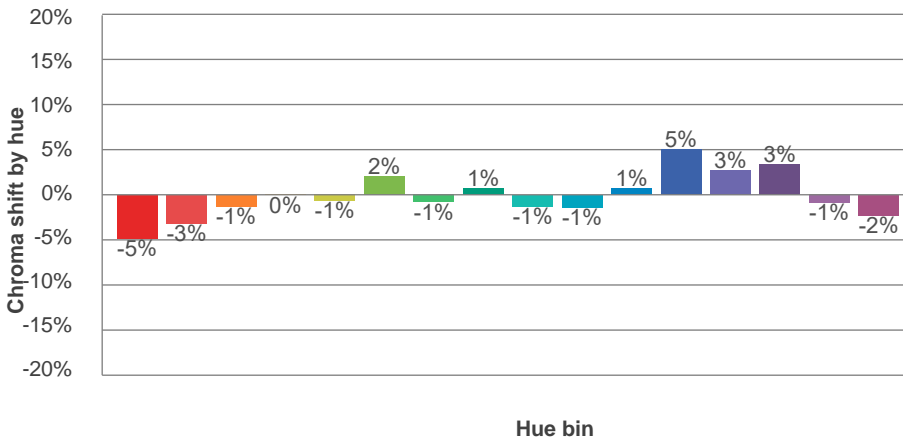
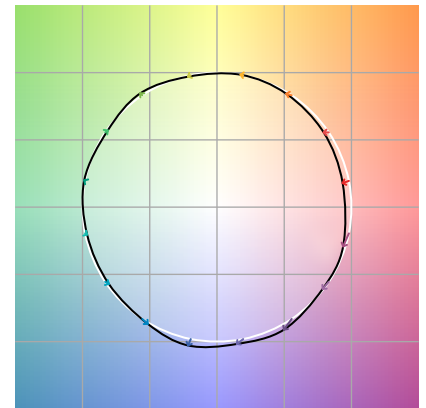

Color distortion

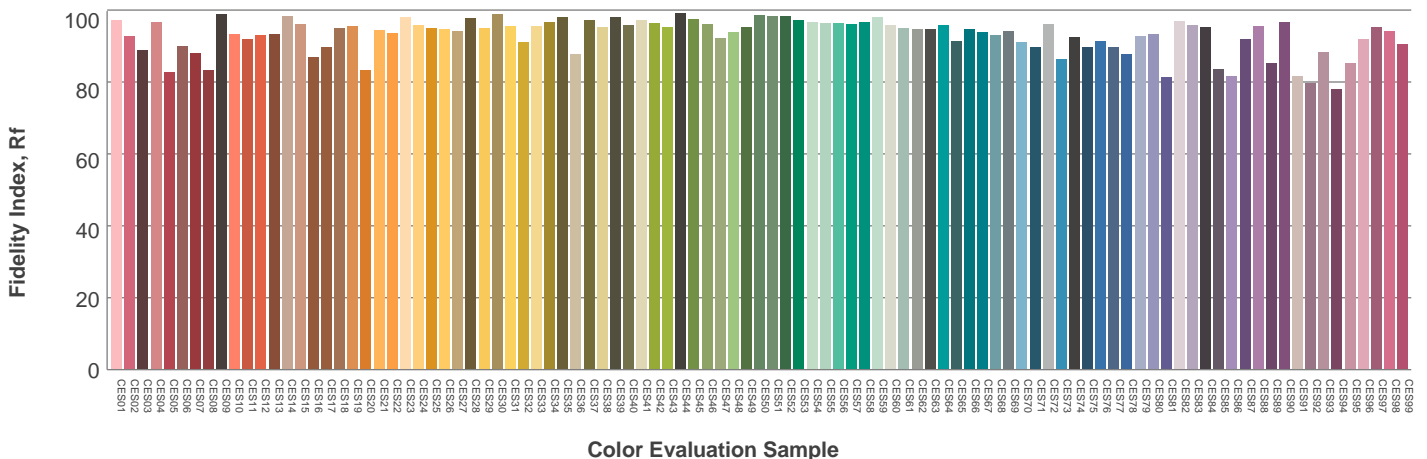

Beam details

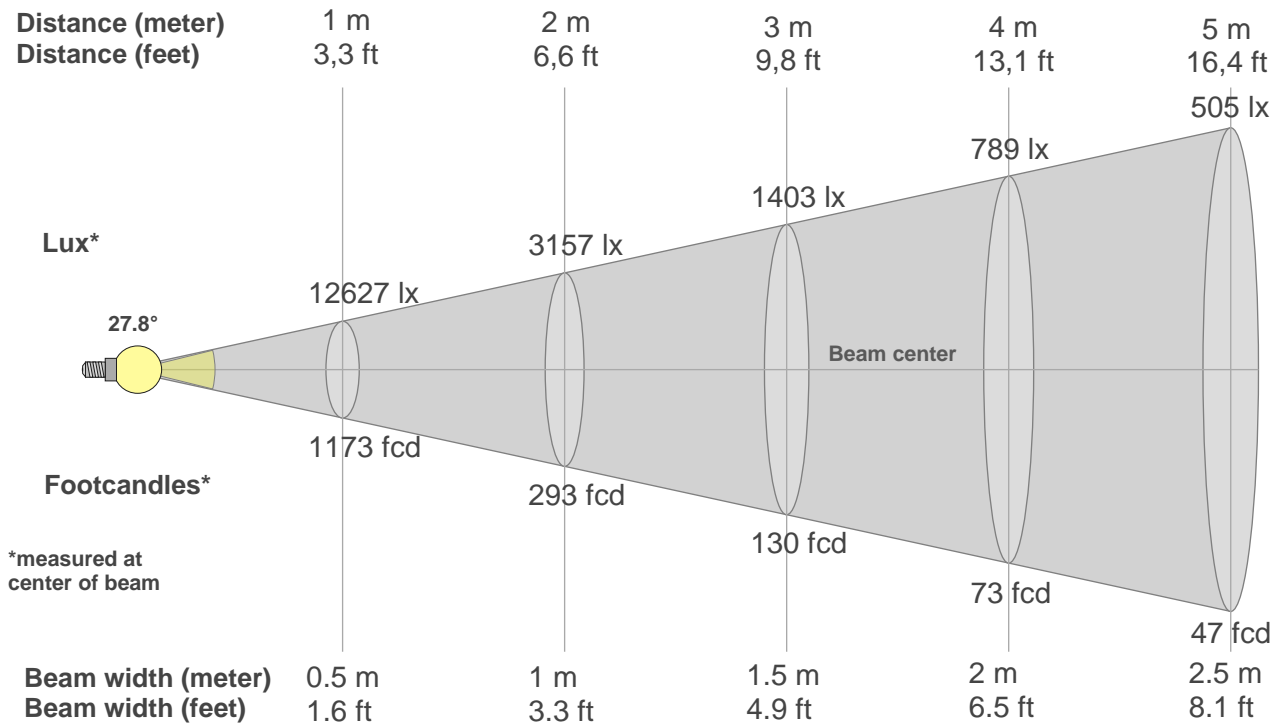

Beam intensities from 1-20m

1m	2m	3m	4m	5m	6m	7m	8m	9m	10m	11m	12m	13m	14m	15m	16m	17m	18m	19m	20m
3.3ft	6.6ft	9.8ft	13.1ft	16.4ft	19.7ft	23ft	26.2ft	29.5ft	32.8ft	36.1ft	39.4ft	42.7ft	45.9ft	49.2ft	52.5ft	55.8ft	59.1ft	62.3ft	65.6ft
12627lx	3157lx	1403lx	789lx	505lx	351lx	258lx	197lx	156lx	126lx	104lx	88lx	75lx	64lx	56lx	49lx	44lx	39lx	35lx	32lx
1173.1fcd	293.3fcd	130.3fcd	73.3fcd	46.9fcd	32.6fcd	23.9fcd	18.3fcd	14.5fcd	11.7fcd	9.7fcd	8.1fcd	6.9fcd	6fcd	5.2fcd	4.6fcd	4.1fcd	3.6fcd	3.2fcd	2.9fcd

Intensities in 0° c-plane

0°	2°	4°	6°	8°	10°	12°	14°	16°	18°	20°	22°	24°	26°	28°	30°	32°	34°	36°	38°
12.6K	12.5K	12.3K	11.9K	11.1K	9.8K	8.1K	6.2K	4.5K	3.1K	2.3K	1.9K	1.6K	1.5K	1.3K	1.0K	0.7K	0.4K	0.2K	0.1K
100%	99%	97%	94%	88%	78%	64%	49%	35%	24%	18%	15%	13%	12%	10%	8%	6%	3%	1%	0%

Intensities in 90° c-plane

0°	2°	4°	6°	8°	10°	12°	14°	16°	18°	20°	22°	24°	26°	28°	30°	32°	34°	36°	38°
12.6K	12.5K	12.3K	11.9K	11.1K	9.8K	8.1K	6.2K	4.5K	3.1K	2.3K	1.9K	1.6K	1.5K	1.3K	1.0K	0.7K	0.4K	0.2K	0.1K
100%	99%	97%	94%	88%	78%	64%	49%	35%	24%	18%	15%	13%	12%	10%	8%	6%	3%	1%	0%

Intensities in 180° c-plane

0°	2°	4°	6°	8°	10°	12°	14°	16°	18°	20°	22°	24°	26°	28°	30°	32°	34°	36°	38°
12.6K	12.5K	12.3K	11.8K	11.0K	9.8K	8.1K	6.2K	4.5K	3.2K	2.3K	1.9K	1.6K	1.5K	1.3K	1.1K	0.7K	0.4K	0.2K	0.1K
100%	99%	97%	93%	87%	77%	64%	49%	36%	25%	18%	15%	13%	12%	10%	8%	6%	4%	2%	1%

Intensities in 270° c-plane

0°	2°	4°	6°	8°	10°	12°	14°	16°	18°	20°	22°	24°	26°	28°	30°	32°	34°	36°	38°
12.6K	12.5K	12.3K	11.8K	11.0K	9.8K	8.1K	6.2K	4.5K	3.2K	2.3K	1.9K	1.6K	1.5K	1.3K	1.1K	0.7K	0.4K	0.2K	0.1K
100%	99%	97%	93%	87%	77%	64%	49%	36%	25%	18%	15%	13%	12%	10%	8%	6%	4%	2%	1%

Beam angle 50%	Field angle 10%	Cutoff angle 2,5%	Intensity ratio in 120° cone	Intensity ratio in 90° cone
27.8°	56.8°	69.6°	99.5%	99.3%

LAMPS (number of lamps)
50

Light planning Luminaire budgetary diagram

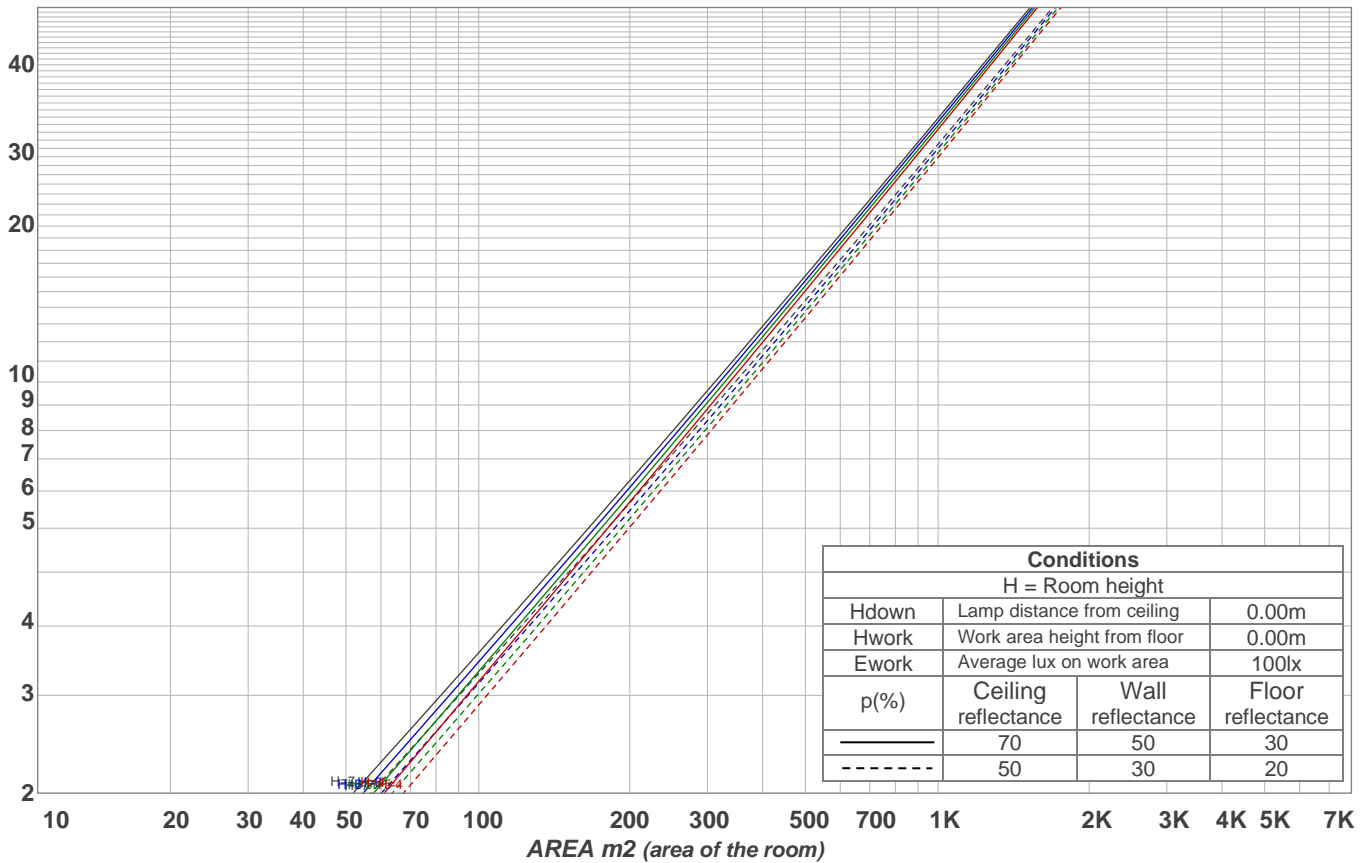

Luminaire budgetary diagram AREA m2 (area of the room) Coefficients of Utilization

Ceiling reflectance	80				70				50			30			10			0
Wall reflectance	70	50	30	10	70	50	30	10	50	30	10	50	30	10	50	30	10	0
Floor reflectance	20	20	20	20	20	20	20	20	20	20	20	20	20	20	20	20	20	0
RCR	(RCR: Room Cavity Ratio)																	
	Room Values are expressed as percentage of Lumens delivered to the task surface																	
0	119	119	119	119	116	116	116	116	111	111	111	106	106	106	102	102	102	100
1	115	112	110	109	112	110	109	107	106	105	104	103	102	101	99	98	98	96
2	111	107	104	101	109	105	102	100	102	100	98	99	97	96	96	95	94	92
3	107	102	98	95	105	101	97	94	98	95	93	96	93	91	94	92	90	89
4	103	98	93	90	102	97	93	90	95	91	89	93	90	88	91	89	87	85
5	100	94	89	86	99	93	89	86	91	88	85	90	87	84	88	86	84	82
6	97	90	86	83	95	89	85	82	88	84	82	87	84	81	86	83	81	80
7	94	87	82	79	93	86	82	79	85	81	79	84	81	78	83	80	78	77
8	91	84	79	76	90	83	79	76	82	79	76	82	78	76	81	78	75	74
9	88	81	77	74	87	81	77	74	80	76	74	79	76	73	78	75	73	72
10	86	79	74	71	85	78	74	71	78	74	71	77	73	71	76	73	71	70

Zonal Lumen Summary

0°-10°	10°-20°	20°-30°	30°-40°	40°-50°	50°-60°	60°-70°	70°-80°	80°-90°
1084 lm	1453 lm	723 lm	223 lm	6.17 lm	4.24 lm	4.14 lm	6.20 lm	8.66 lm
90°-100°	100°-110°	110°-120°	120°-130°	130°-140°	140°-150°	150°-160°	160°-170°	170°-180°
0.000 lm	0.000 lm	0.000 lm	0.000 lm	0.000 lm	0.000 lm	0.000 lm	0.000 lm	0.000 lm