

Light efficiency:



Output: 1664 lm



Light quality:



Peak: 10186 cd

Power: 20.8 W

Beam angle

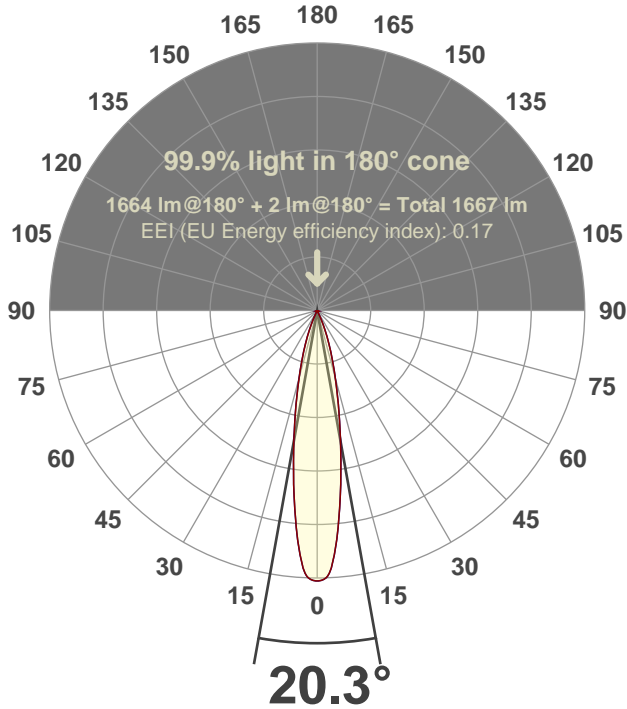

Test number:

SCW3D-R-C20-30k-20°-Rev1

Luminaire Model:

Scope Wonder 3" Round Downlight-C20-30k-20°

Date and time:

5/27/2021 11:13:49 AM

LUM: 1664

Spectra

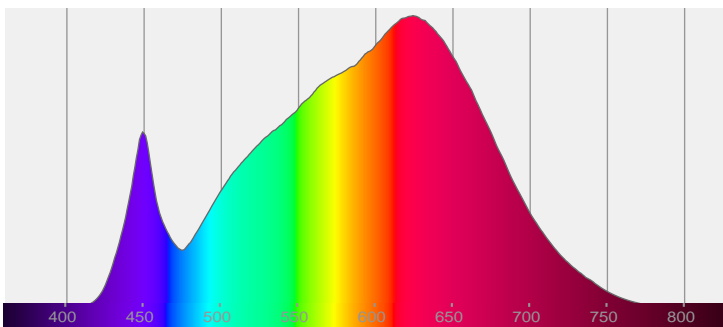

CRI: 92.7 (R1-R8)

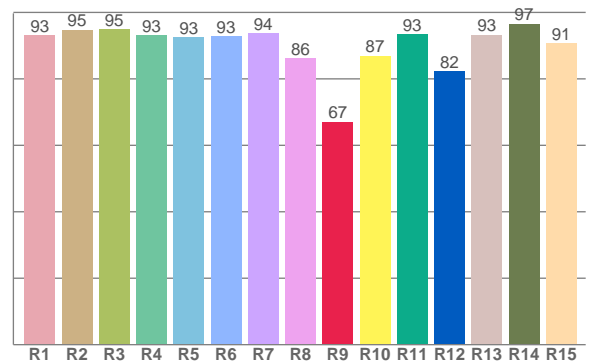

Color parameters

	Color rendering index	Red component	Color fidelity	Color gamut	Color quality scale	Color coordinate cie 1931	Color coordinate cie 1931	Color coordinate	Color coordinate	Color deviation from black body
	CRI	CRI R9	TM30 R <sub>f</sub>	TM30 R <sub>g</sub>	CQS	x	y	u	v	Δuv
	92.7	67.1	91.5	101.7	90.6	0.424	0.396	0.245	0.344	-0.0011

**$R_f$  91.5**  
Fidelity index  $R_f$

---

**$R_g$  101.7**  
Gammut index  $R_g$

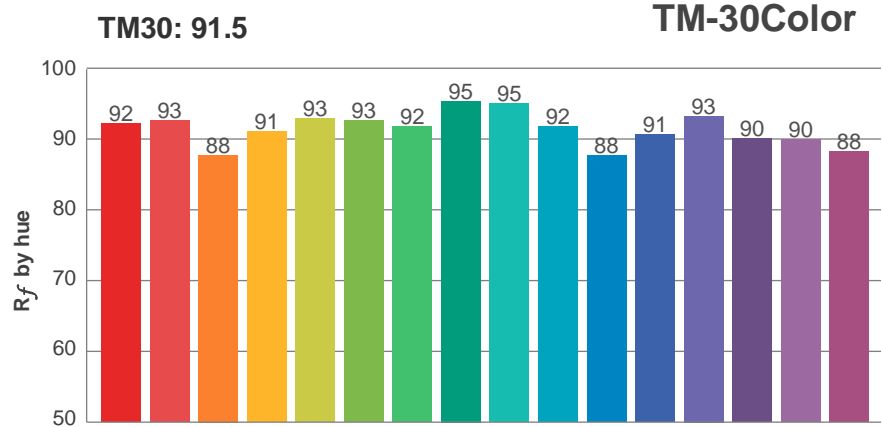

Hue Bin	$R_f$	Graphic shifts (%)	
		Chroma	Hue
1	92	-4%	-2%
2	93	-3%	3%
3	88	-1%	6%
4	91	2%	5%
5	93	4%	4%
6	93	5%	-1%
7	92	2%	-5%
8	95	0%	-3%
9	95	-3%	0%
10	92	-3%	3%
11	88	0%	8%
12	91	5%	3%
13	93	4%	-1%
14	90	6%	-5%
15	90	2%	-6%
16	88	0%	-10%

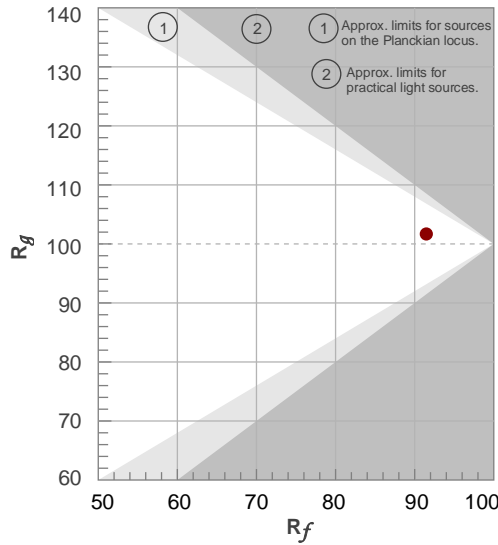

Color vector graphics

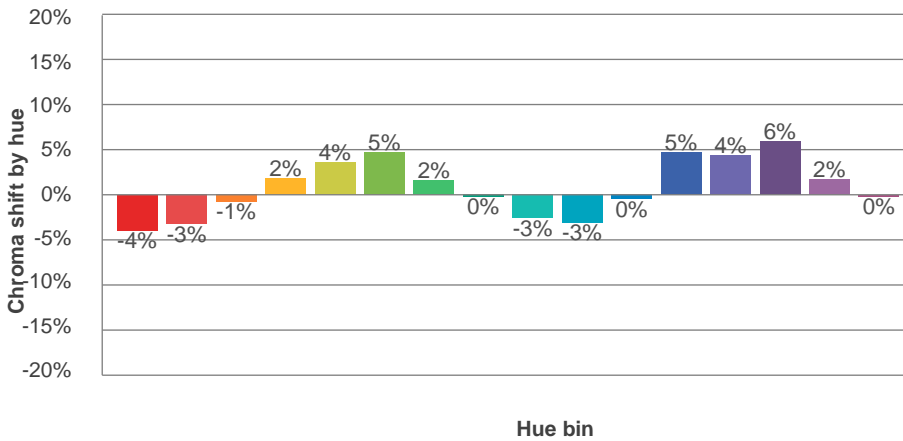
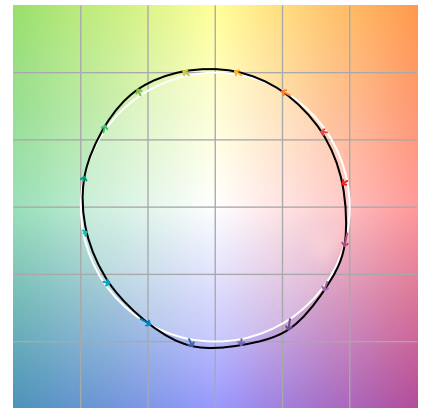

Color distortion

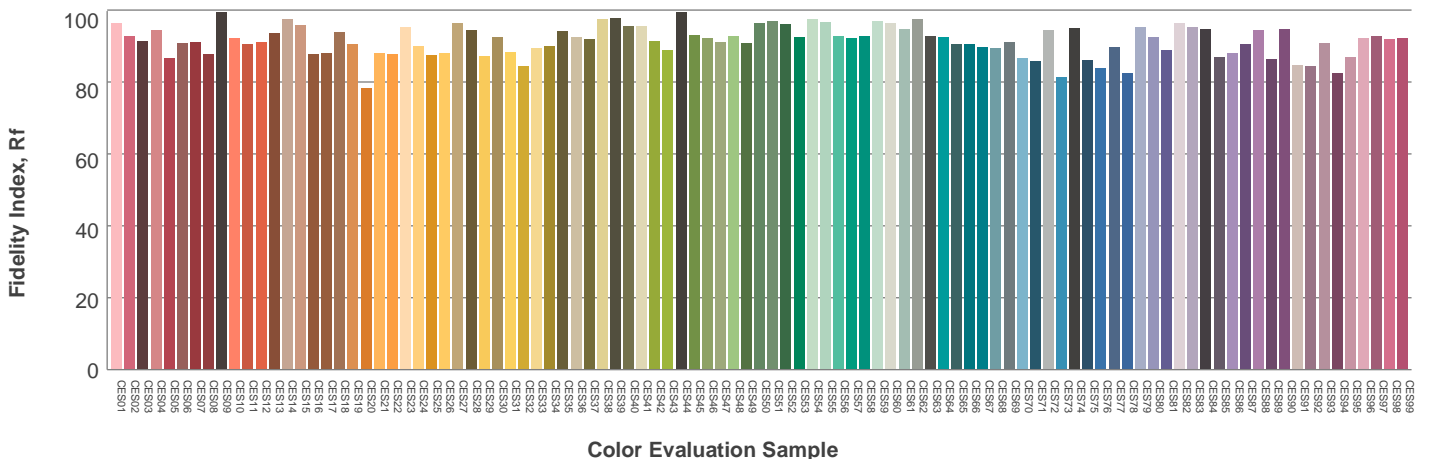
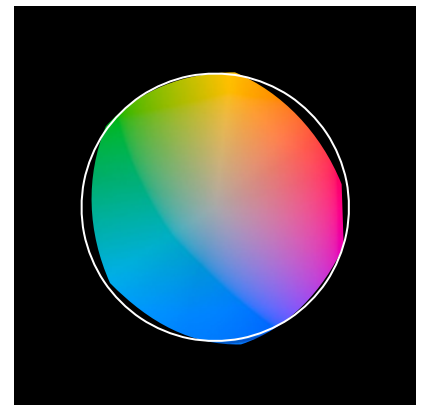

### Beam details

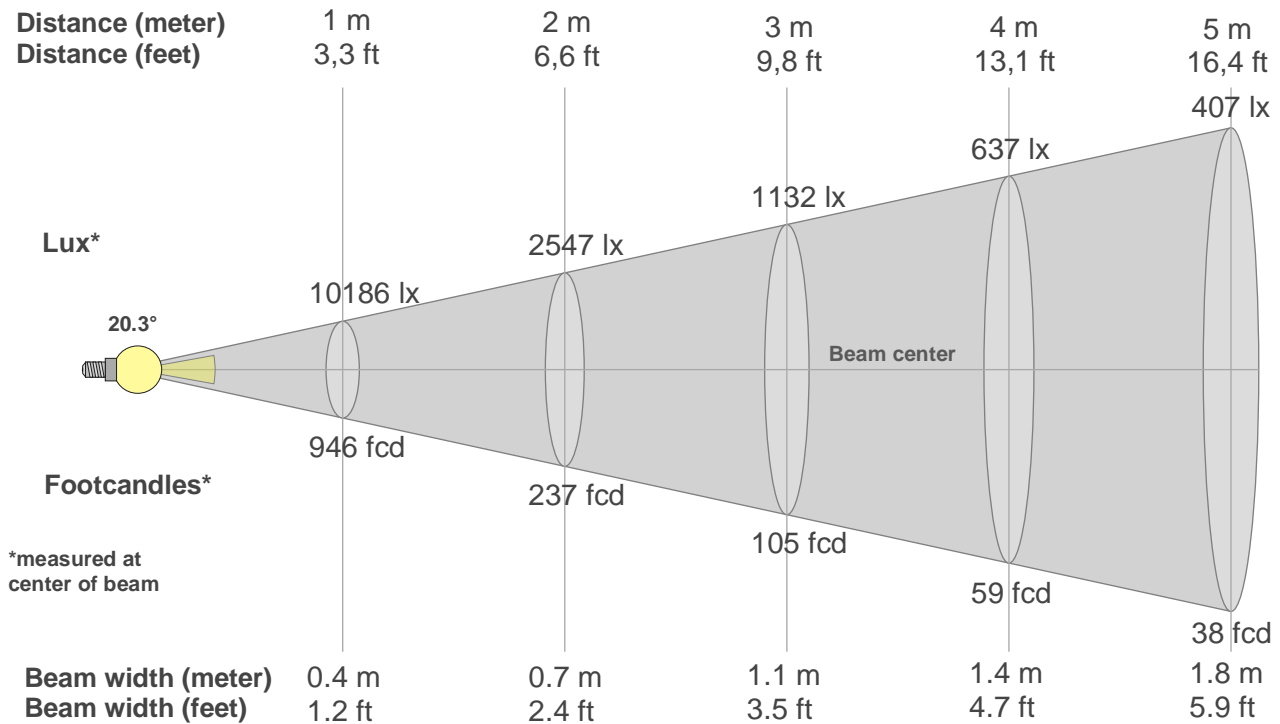

#### Beam intensities from 1-20m

1m	2m	3m	4m	5m	6m	7m	8m	9m	10m	11m	12m	13m	14m	15m	16m	17m	18m	19m	20m
3.3ft	6.6ft	9.8ft	13.1ft	16.4ft	19.7ft	23ft	26.2ft	29.5ft	32.8ft	36.1ft	39.4ft	42.7ft	45.9ft	49.2ft	52.5ft	55.8ft	59.1ft	62.3ft	65.6ft
10186lx	2547lx	1132lx	637lx	407lx	283lx	208lx	159lx	126lx	102lx	84lx	71lx	60lx	52lx	45lx	40lx	35lx	31lx	28lx	25lx
946.3fc	236.6fc	105.1fc	59.1fcd	37.9fcd	26.3fcd	19.3fcd	14.8fcd	11.7fcd	9.5fcd	7.8fcd	6.6fcd	5.6fcd	4.8fcd	4.2fcd	3.7fcd	3.3fcd	2.9fcd	2.6fcd	2.4fcd

#### Intensities in 0° c-plane

0°	2°	4°	6°	8°	10°	12°	14°	16°	18°	20°	22°	24°	26°	28°	30°	32°	34°	36°	38°
10.2K	10.2K	9.3K	8.0K	6.5K	5.2K	4.0K	3.1K	2.4K	1.8K	1.2K	0.8K	0.5K	0.2K	0.1K	0.0K	0.0K	0.0K	0.0K	0.0K
100%	100%	91%	78%	64%	51%	40%	31%	23%	17%	12%	8%	5%	2%	1%	0%	0%	0%	0%	0%

#### Intensities in 90° c-plane

0°	2°	4°	6°	8°	10°	12°	14°	16°	18°	20°	22°	24°	26°	28°	30°	32°	34°	36°	38°
10.2K	10.2K	9.3K	8.0K	6.5K	5.2K	4.0K	3.1K	2.4K	1.8K	1.2K	0.8K	0.5K	0.2K	0.1K	0.0K	0.0K	0.0K	0.0K	0.0K
100%	100%	91%	78%	64%	51%	40%	31%	23%	17%	12%	8%	5%	2%	1%	0%	0%	0%	0%	0%

#### Intensities in 180° c-plane

0°	2°	4°	6°	8°	10°	12°	14°	16°	18°	20°	22°	24°	26°	28°	30°	32°	34°	36°	38°
10.2K	10.2K	9.3K	8.0K	6.5K	5.2K	4.0K	3.1K	2.4K	1.8K	1.2K	0.8K	0.5K	0.2K	0.1K	0.0K	0.0K	0.0K	0.0K	0.0K
100%	100%	91%	78%	64%	51%	40%	31%	23%	17%	12%	8%	5%	2%	1%	0%	0%	0%	0%	0%

#### Intensities in 270° c-plane

0°	2°	4°	6°	8°	10°	12°	14°	16°	18°	20°	22°	24°	26°	28°	30°	32°	34°	36°	38°
10.2K	10.2K	9.3K	8.0K	6.5K	5.2K	4.0K	3.1K	2.4K	1.8K	1.2K	0.8K	0.5K	0.2K	0.1K	0.0K	0.0K	0.0K	0.0K	0.0K
100%	100%	91%	78%	64%	51%	40%	31%	23%	17%	12%	8%	5%	2%	1%	0%	0%	0%	0%	0%

Beam angle 50%	Field angle 10%	Cutoff angle 2,5%	Intensity ratio in 120° cone	Intensity ratio in 90° cone
20.3°	42.2°	51.6°	99.7%	99.5%

LAMPS (number of lamps)

50

### Light planning Luminaire budgetary diagram

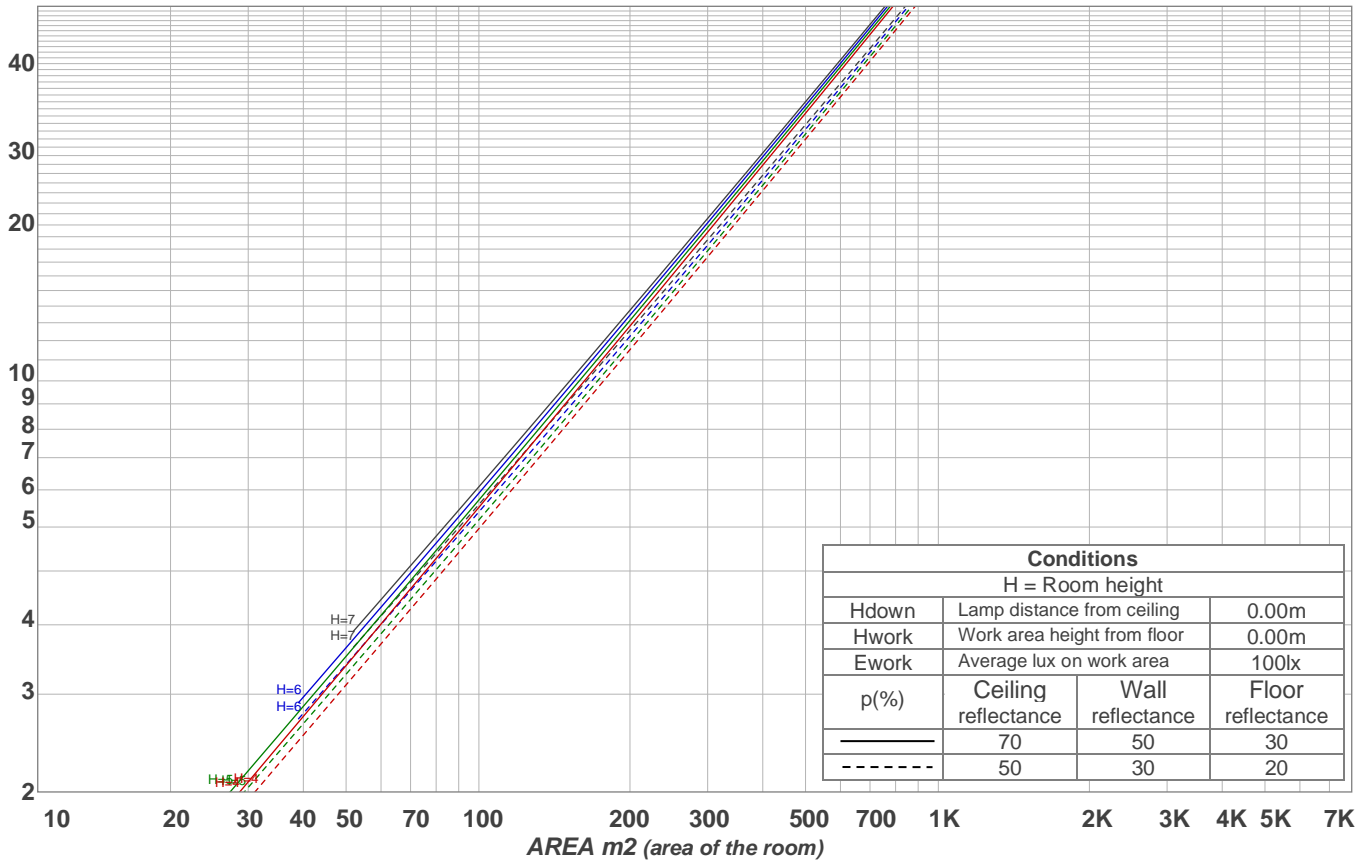

### Luminaire budgetary diagram AREA m2 (area of the room) Coefficients of Utilization

Ceiling reflectance	80				70				50			30			10			0	
Wall reflectance	70	50	30	10	70	50	30	10	50	30	10	50	30	10	50	30	10	0	
Floor reflectance	20	20	20	20	20	20	20	20	20	20	20	20	20	20	20	20	20	20	0
RCR	(RCR: Room Cavity Ratio)																		
	Room Values are expressed as percentage of Lumens delivered to the task surface																		
0	119	119	119	119	116	116	116	116	111	111	111	106	106	106	102	102	102	100	
1	115	113	112	110	113	111	110	108	107	106	105	104	103	102	100	100	99	97	
2	112	109	106	103	110	107	104	102	104	102	100	101	99	98	98	97	96	95	
3	109	104	101	99	107	103	100	98	101	98	96	99	97	95	96	95	93	92	
4	106	101	97	95	104	100	97	94	98	95	93	96	94	92	95	93	91	90	
5	103	98	94	91	102	97	94	91	95	92	90	94	91	89	93	90	89	88	
6	101	95	91	88	99	94	91	88	93	90	88	92	89	87	91	88	87	86	
7	98	92	89	86	97	92	88	86	91	88	85	90	87	85	89	86	85	84	
8	96	90	86	84	95	90	86	84	89	86	83	88	85	83	87	85	83	82	
9	94	88	84	82	93	87	84	82	87	84	81	86	83	81	85	83	81	80	
10	92	86	82	80	91	85	82	80	85	82	80	84	81	79	84	81	79	78	

### Zonal Lumen Summary

0°-10°	10°-20°	20°-30°	30°-40°	40°-50°	50°-60°	60°-70°	70°-80°	80°-90°
705 lm	757 lm	187 lm	7.59 lm	3.05 lm	1.54 lm	1.08 lm	1.12 lm	1.03 lm
90°-100°	100°-110°	110°-120°	120°-130°	130°-140°	140°-150°	150°-160°	160°-170°	170°-180°
0.000 lm	0.000 lm	0.000 lm	0.000 lm	0.000 lm	0.000 lm	0.000 lm	0.000 lm	0.000 lm

### UGR

p Ceiling	70	70	50	50	30	70	70	50	50	30	
p Walls	50	30	50	30	30	50	30	50	30	30	
p Floor	20	20	20	20	20	20	20	20	20	20	
Room size X    Y	Viewing direction at right angles to lamp axis					Viewing direction parallel to lamp axis					
2H	2H	9.1	9.4	9.1	9.6	9.8	9.1	9.4	9.1	9.6	9.8
	3H	9.8	10.3	10.1	10.5	10.7	9.8	10.3	10.1	10.5	10.7
	4H	10.6	11.1	11.0	11.3	11.6	10.6	11.1	11.0	11.3	11.6
	6H	12.1	12.5	12.4	12.8	13.1	12.1	12.5	12.4	12.8	13.1
	8H	12.9	13.3	13.2	13.7	14.0	12.9	13.3	13.2	13.7	14.0
	12H	14.0	14.4	14.4	14.8	15.2	14.0	14.4	14.4	14.8	15.2
4H	2H	9.1	9.6	9.5	9.8	10.0	9.1	9.6	9.5	9.8	10.0
	3H	10.4	10.8	10.7	11.1	11.5	10.4	10.8	10.7	11.1	11.5
	4H	11.5	11.8	11.9	12.2	12.7	11.5	11.8	11.9	12.2	12.7
	6H	13.2	13.6	13.7	14.0	14.3	13.2	13.6	13.7	14.0	14.3
	8H	14.2	14.6	14.8	15.0	15.3	14.2	14.6	14.8	15.0	15.3
	12H	15.5	15.8	16.0	16.2	16.7	15.5	15.8	16.0	16.2	16.7
8H	4H	12.0	12.4	12.5	12.8	13.1	12.0	12.4	12.5	12.8	13.1
	6H	14.1	14.4	14.6	14.8	15.4	14.1	14.4	14.6	14.8	15.4
	8H	15.4	15.6	16.0	16.1	16.8	15.4	15.6	16.0	16.1	16.8
	12H	17.0	17.1	17.6	17.6	18.2	17.0	17.1	17.6	17.6	18.2
12H	4H	12.2	12.5	12.7	12.9	13.3	12.2	12.5	12.7	12.9	13.3
	6H	14.5	14.7	15.0	15.2	15.8	14.5	14.7	15.0	15.2	15.8
	8H	15.8	16.0	16.4	16.5	17.1	15.8	16.0	16.4	16.5	17.1

Corrected glare indices referring to 1664 lm total luminous flux