

Light efficiency:



Output: 1592 lm

Light quality:



Peak: 4756 cd

Power: 20.8 W

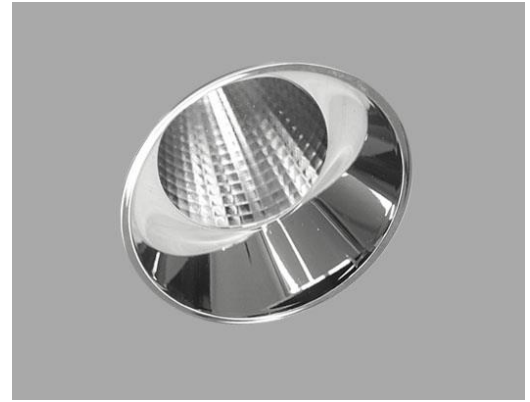

Beam angle

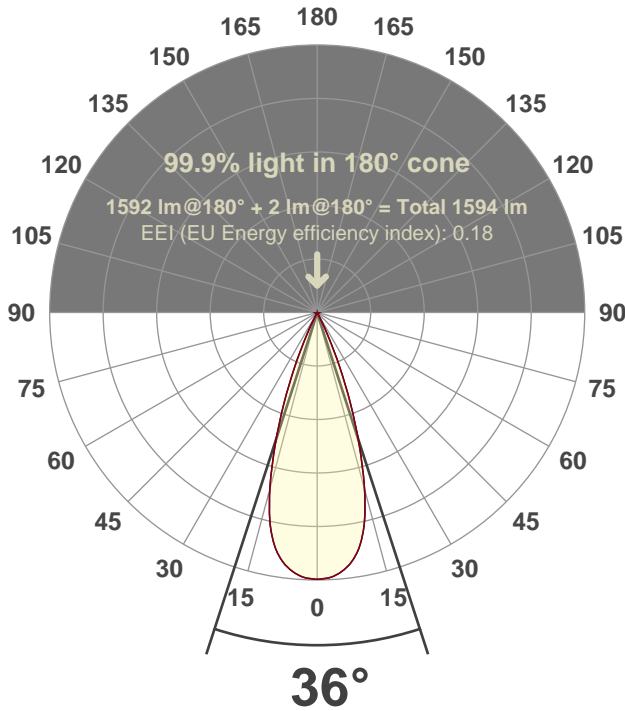

Test number:

SCW3D-R-C20-30k-36°-Rev1

Luminaire Model:

Scope Wonder 3" Round Downlight-C20-30k-36°

Date and time:

5/27/2021 11:00:24 AM

LUM: 1592

Spectra

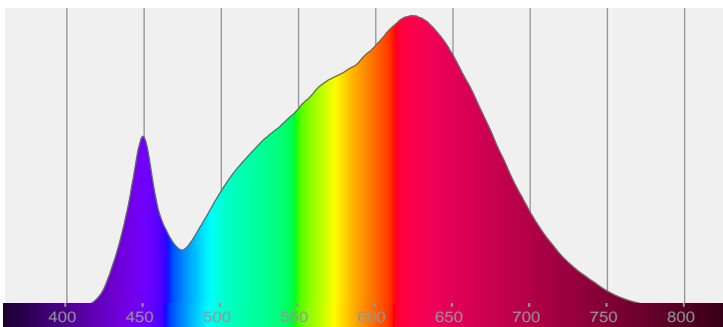

CRI: 92.7 (R1-R8)

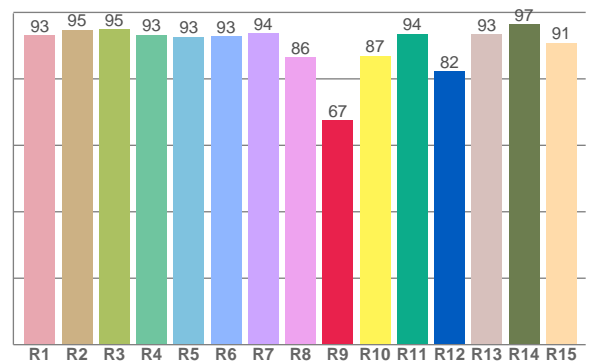

Color parameters

	Color rendering index	Red component	Color fidelity	Color gamut	Color quality scale	Color coordinate cie 1931	Color coordinate cie 1931	Color coordinate	Color coordinate	Color deviation from black body
	CRI	CRI R9	TM30 R <sub>f</sub>	TM30 R <sub>g</sub>	CQS	x	y	u	v	Δuv
	92.7	67.5	91.5	101.7	90.7	0.424	0.397	0.246	0.344	-0.0010

**$R_f$  91.5**  
Fidelity index  $R_f$

---

**$R_g$  101.7**  
Gammut index  $R_g$

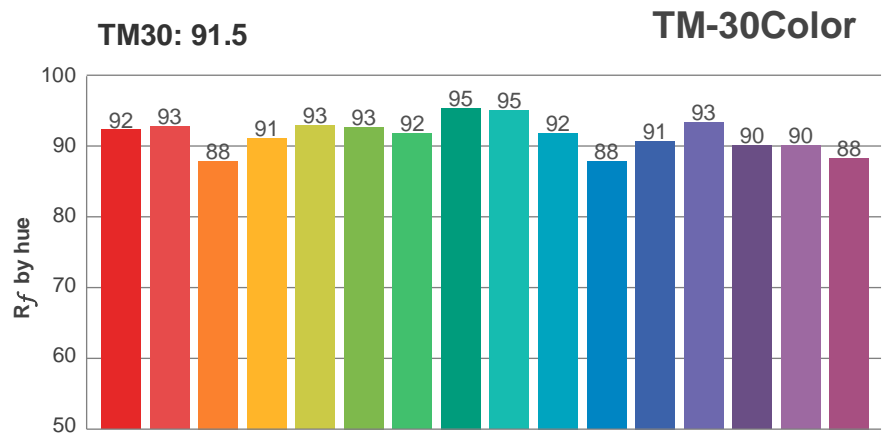

Hue Bin	$R_f$	Graphic shifts (%)	
		Chroma	Hue
1	92	-4%	-2%
2	93	-3%	3%
3	88	-1%	6%
4	91	2%	5%
5	93	4%	4%
6	93	5%	-1%
7	92	2%	-5%
8	95	0%	-3%
9	95	-3%	-1%
10	92	-3%	3%
11	88	0%	8%
12	91	5%	3%
13	93	4%	-1%
14	90	6%	-5%
15	90	2%	-6%
16	88	0%	-10%

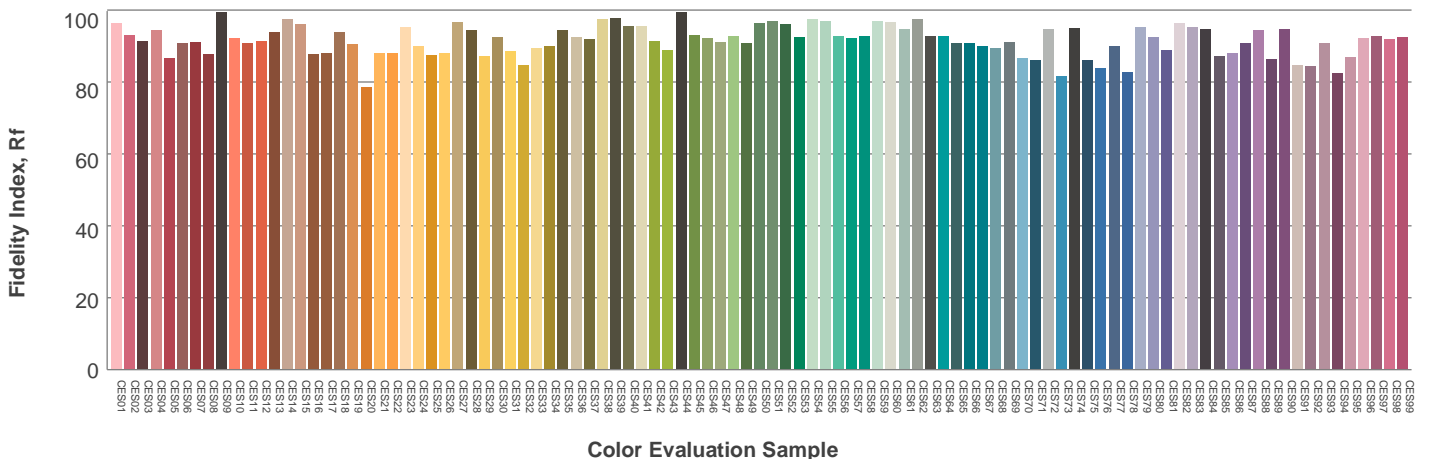
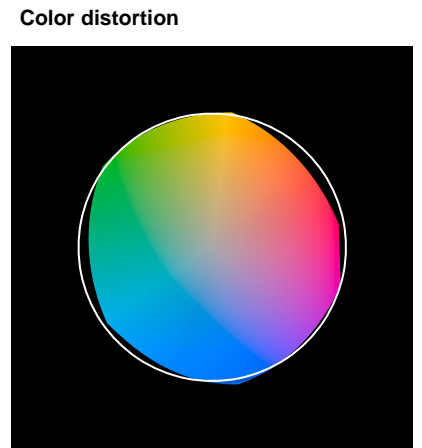
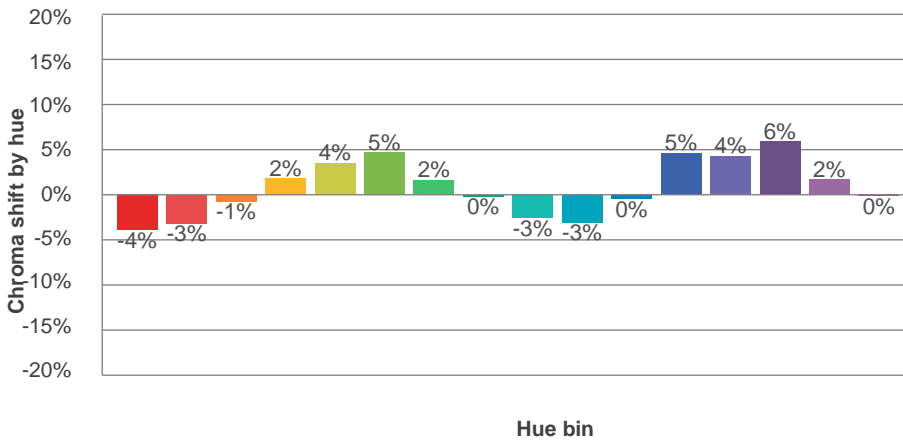
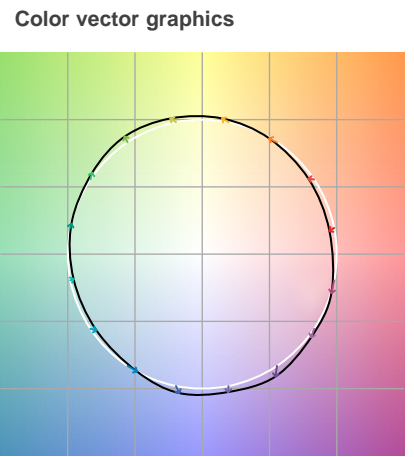
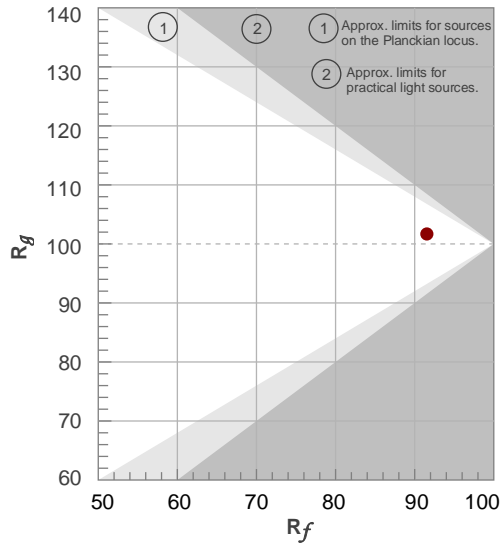

### Beam details

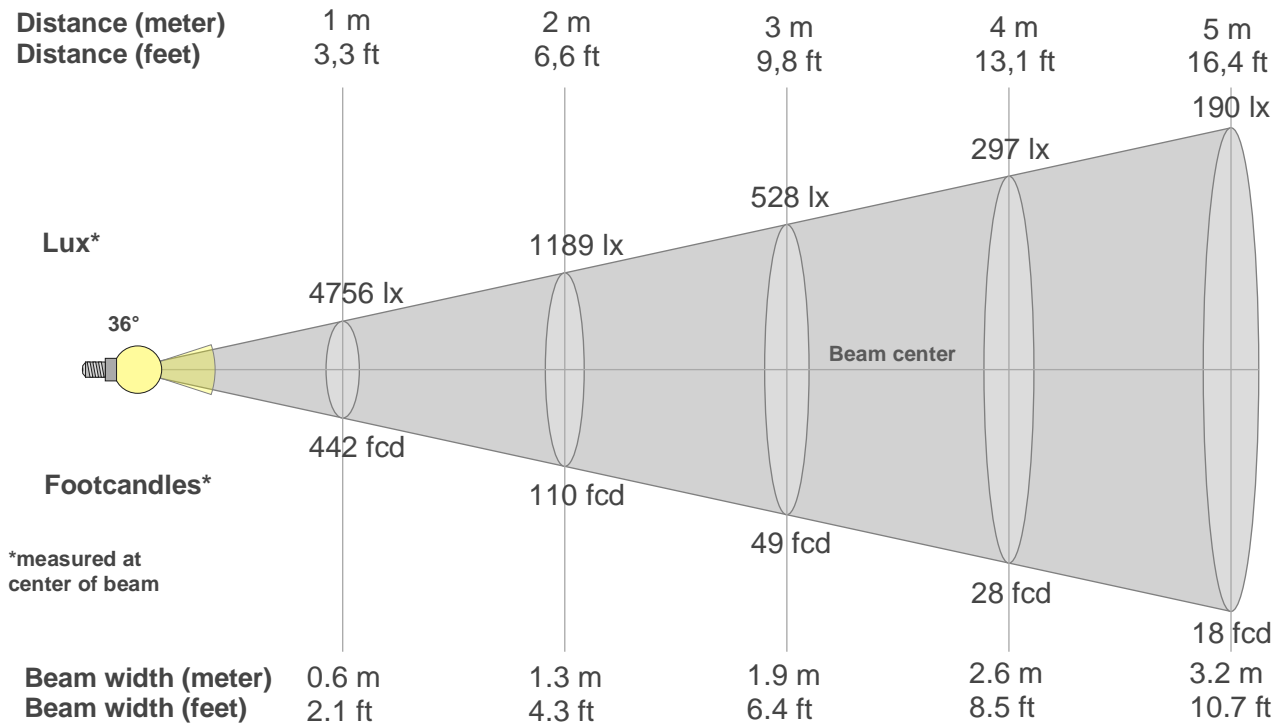

#### Beam intensities from 1-20m

1m	2m	3m	4m	5m	6m	7m	8m	9m	10m	11m	12m	13m	14m	15m	16m	17m	18m	19m	20m
3.3ft	6.6ft	9.8ft	13.1ft	16.4ft	19.7ft	23ft	26.2ft	29.5ft	32.8ft	36.1ft	39.4ft	42.7ft	45.9ft	49.2ft	52.5ft	55.8ft	59.1ft	62.3ft	65.6ft
4756lx	1189lx	528lx	297lx	190lx	132lx	97lx	74lx	59lx	48lx	39lx	33lx	28lx	24lx	21lx	19lx	16lx	15lx	13lx	12lx
441.8fcd	110.5fcd	49.1fcd	27.6fcd	17.7fcd	12.3fcd	9fcd	6.9fcd	5.5fcd	4.4fcd	3.7fcd	3.1fcd	2.6fcd	2.3fcd	2fcd	1.7fcd	1.5fcd	1.4fcd	1.2fcd	1.1fcd

#### Intensities in 0° c-plane

0°	2°	4°	6°	8°	10°	12°	14°	16°	18°	20°	22°	24°	26°	28°	30°	32°	34°	36°	38°
4756	4740	4692	4605	4476	4269	3953	3517	2978	2376	1778	1216	731	362	131	43	28	20	15	11
100%	100%	99%	97%	94%	90%	83%	74%	63%	50%	37%	26%	15%	8%	3%	1%	1%	0%	0%	0%

#### Intensities in 90° c-plane

0°	2°	4°	6°	8°	10°	12°	14°	16°	18°	20°	22°	24°	26°	28°	30°	32°	34°	36°	38°
4756	4740	4692	4605	4476	4269	3953	3517	2978	2376	1778	1216	731	362	131	43	28	20	15	11
100%	100%	99%	97%	94%	90%	83%	74%	63%	50%	37%	26%	15%	8%	3%	1%	1%	0%	0%	0%

#### Intensities in 180° c-plane

0°	2°	4°	6°	8°	10°	12°	14°	16°	18°	20°	22°	24°	26°	28°	30°	32°	34°	36°	38°
4756	4740	4692	4605	4476	4269	3953	3517	2978	2376	1778	1216	731	362	131	43	28	20	15	11
100%	100%	99%	97%	94%	90%	83%	74%	63%	50%	37%	26%	15%	8%	3%	1%	1%	0%	0%	0%

#### Intensities in 270° c-plane

0°	2°	4°	6°	8°	10°	12°	14°	16°	18°	20°	22°	24°	26°	28°	30°	32°	34°	36°	38°
4756	4740	4692	4605	4476	4269	3953	3517	2978	2376	1778	1216	731	362	131	43	28	20	15	11
100%	100%	99%	97%	94%	90%	83%	74%	63%	50%	37%	26%	15%	8%	3%	1%	1%	0%	0%	0%

Beam angle 50%	Field angle 10%	Cutoff angle 2,5%	Intensity ratio in 120° cone	Intensity ratio in 90° cone
36°	50.4°	56.6°	99.7%	99.5%

LAMPS (number of lamps)

50

### Light planning Luminaire budgetary diagram

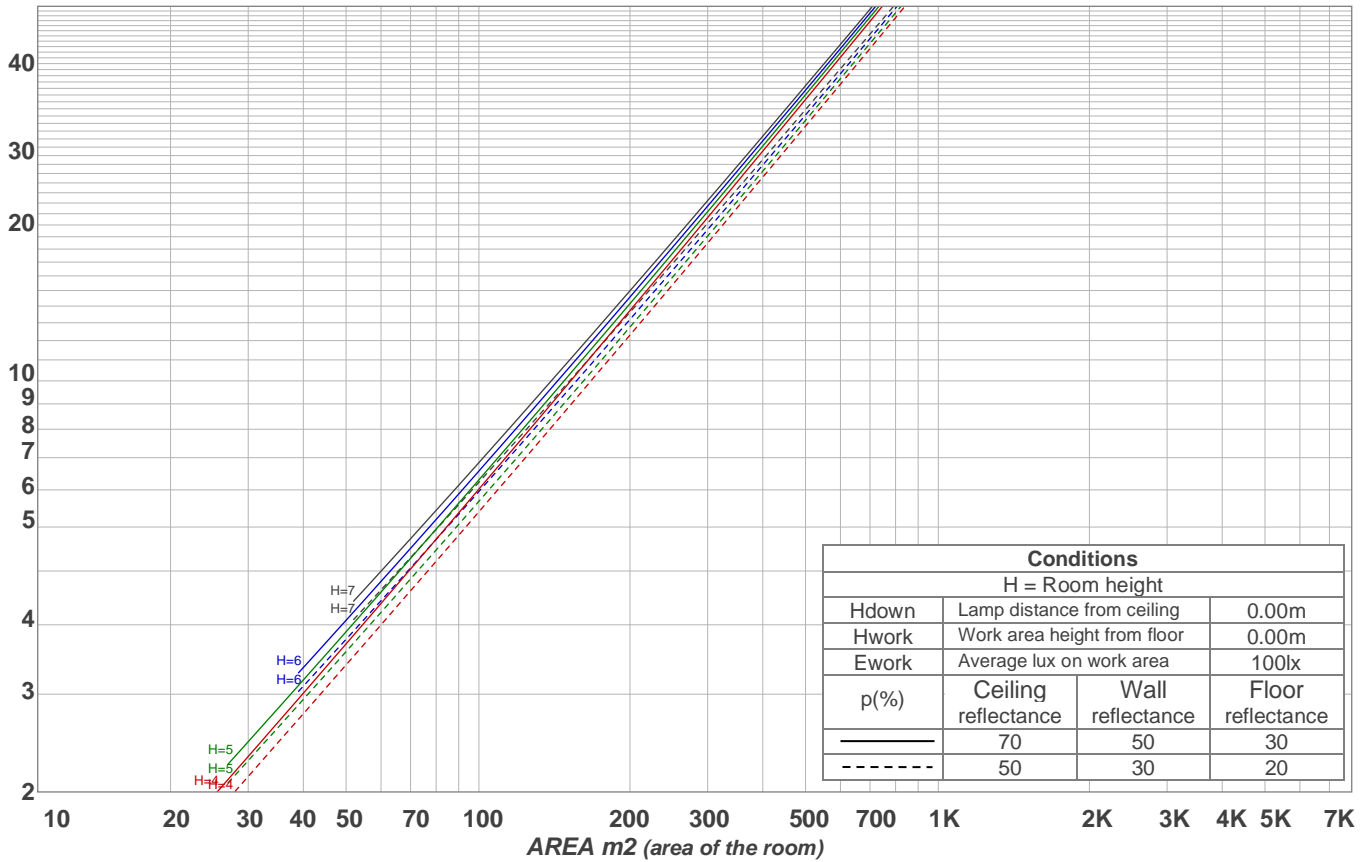

### Luminaire budgetary diagram AREA m2 (area of the room) Coefficients of Utilization

Ceiling reflectance	80				70				50			30			10			0
Wall reflectance	70	50	30	10	70	50	30	10	50	30	10	50	30	10	50	30	10	0
Floor reflectance	20	20	20	20	20	20	20	20	20	20	20	20	20	20	20	20	20	0
RCR	(RCR: Room Cavity Ratio)																	
	Room Values are expressed as percentage of Lumens delivered to the task surface																	
0	119	119	119	119	116	116	116	116	111	111	111	106	106	106	102	102	102	100
1	115	113	111	109	113	111	109	107	107	105	104	103	102	101	100	99	98	96
2	111	107	104	102	109	106	103	101	103	100	99	100	98	96	97	96	95	93
3	107	103	99	96	106	101	98	95	99	96	94	97	94	93	95	93	91	90
4	104	99	95	92	103	98	94	91	96	92	90	94	91	89	92	90	88	87
5	101	95	91	88	99	94	90	87	92	89	87	91	88	86	90	87	85	84
6	98	91	87	84	97	91	87	84	89	86	83	88	85	83	87	84	82	81
7	95	88	84	81	94	88	84	81	87	83	81	86	83	80	85	82	80	79
8	92	85	81	78	91	85	81	78	84	80	78	83	80	78	82	79	77	76
9	90	83	79	76	89	82	78	76	82	78	75	81	78	75	80	77	75	74
10	87	80	76	73	86	80	76	73	79	76	73	79	75	73	78	75	73	72

### Zonal Lumen Summary

0°-10°	10°-20°	20°-30°	30°-40°	40°-50°	50°-60°	60°-70°	70°-80°	80°-90°
432 lm	860 lm	279 lm	12.0 lm	4.11 lm	1.75 lm	0.944 lm	0.904 lm	0.953 lm
90°-100°	100°-110°	110°-120°	120°-130°	130°-140°	140°-150°	150°-160°	160°-170°	170°-180°
0.000 lm	0.000 lm	0.000 lm	0.000 lm	0.000 lm	0.000 lm	0.000 lm	0.000 lm	0.000 lm

UGR

p Ceiling	70	70	50	50	30	70	70	50	50	30	
p Walls	50	30	50	30	30	50	30	50	30	30	
p Floor	20	20	20	20	20	20	20	20	20	20	
Room size X Y	Viewing direction at right angles to lamp axis					Viewing direction parallel to lamp axis					
2H	2H	11.3	11.7	11.4	11.9	12.1	11.3	11.7	11.4	11.9	12.1
	3H	11.4	12.0	11.8	12.2	12.4	11.4	12.0	11.8	12.2	12.4
	4H	11.8	12.3	12.2	12.5	12.8	11.8	12.3	12.2	12.5	12.8
	6H	12.6	13.0	12.9	13.3	13.7	12.6	13.0	12.9	13.3	13.7
	8H	13.1	13.5	13.4	13.8	14.2	13.1	13.5	13.4	13.8	14.2
	12H	13.8	14.2	14.1	14.6	15.0	13.8	14.2	14.1	14.6	15.0
4H	2H	11.1	11.7	11.5	11.9	12.1	11.1	11.7	11.5	11.9	12.1
	3H	11.6	12.0	12.0	12.4	12.8	11.6	12.0	12.0	12.4	12.8
	4H	12.1	12.5	12.5	12.9	13.4	12.1	12.5	12.5	12.9	13.4
	6H	13.2	13.7	13.7	14.0	14.3	13.2	13.7	13.7	14.0	14.3
	8H	13.9	14.4	14.5	14.7	15.1	13.9	14.4	14.5	14.7	15.1
	12H	14.9	15.2	15.4	15.6	16.0	14.9	15.2	15.4	15.6	16.0
8H	4H	12.4	12.8	12.9	13.2	13.5	12.4	12.8	12.9	13.2	13.5
	6H	13.8	14.1	14.3	14.6	15.1	13.8	14.1	14.3	14.6	15.1
	8H	14.9	15.1	15.4	15.6	16.2	14.9	15.1	15.4	15.6	16.2
	12H	16.1	16.2	16.7	16.7	17.3	16.1	16.2	16.7	16.7	17.3
12H	4H	12.5	12.8	13.0	13.2	13.7	12.5	12.8	13.0	13.2	13.7
	6H	14.1	14.3	14.6	14.8	15.4	14.1	14.3	14.6	14.8	15.4
	8H	15.2	15.3	15.8	15.9	16.4	15.2	15.3	15.8	15.9	16.4
Corrected glare indices referring to 1592 lm total luminous flux											