

Light efficiency:



Output: 1099 lm



Light quality:



Peak: 12307 cd

Power: 21.0 W

Beam angle

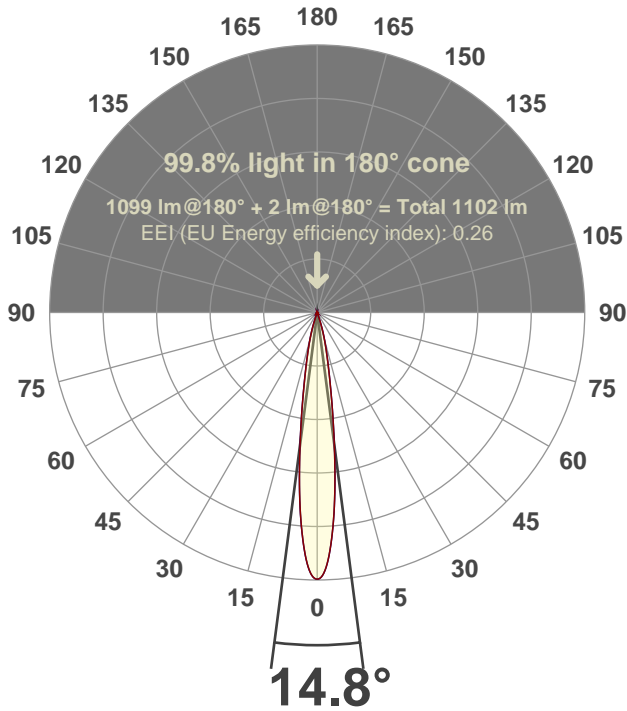

Test number:

CR4D-R-FL-C20-30k-15 (GRF-CZ20-SP-RD)

Luminaire Model:

Core 4" Round Flat C20 30K 15°

Date and time:

6/14/2017 4:22:36 PM

LUM: 1099

Spectra

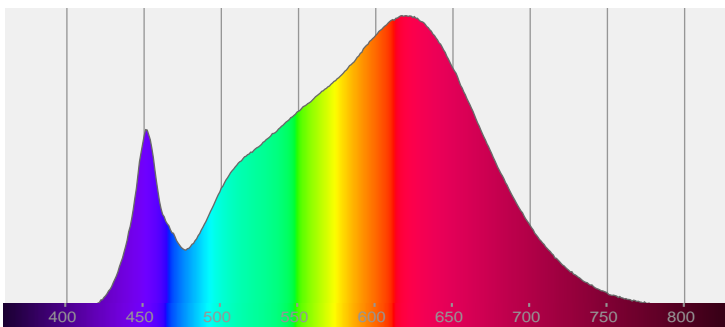

CRI: 92.6 (R1-R8)

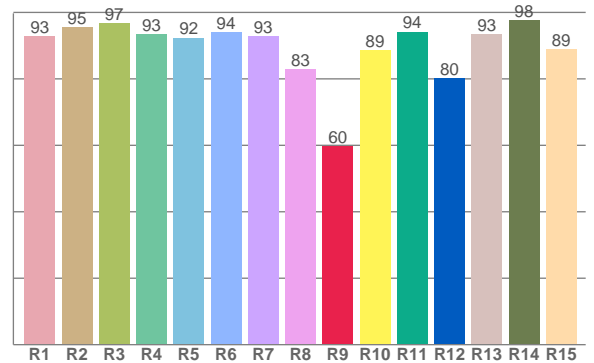

Color parameters

Color rendering index	Red component	Color fidelity	Color gamut	Color quality scale	Color coordinate cie 1931	Color coordinate cie 1931	Color coordinate	Color coordinate	Color deviation from black body
CRI	CRI R9	TM30 R <sub>f</sub>	TM30 R <sub>g</sub>	CQS	x	y	u	v	Δuv
92.6	59.6	91.8	100.1	90.9	0.428	0.401	0.246	0.346	-0.0001

# R<sub>f</sub> 91.8

Fidelity index R<sub>f</sub>

---

# R<sub>g</sub> 100.1

Gammut index R<sub>g</sub>

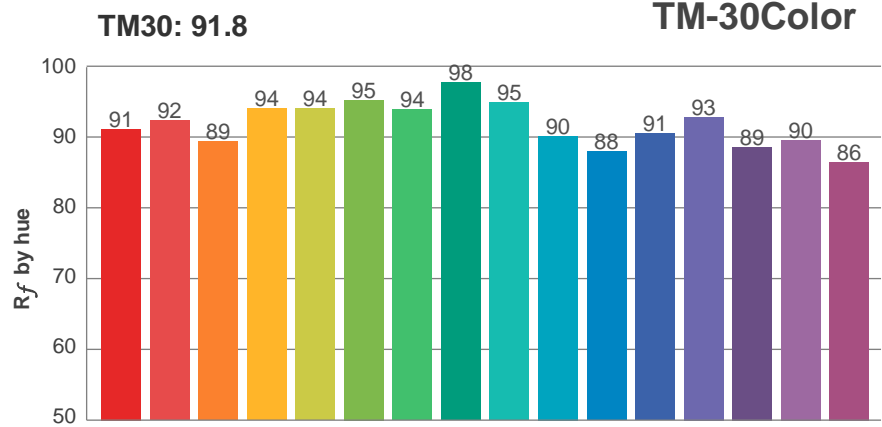

Hue Bin	R <sub>f</sub>	Graphic shifts (%)	
		Chroma	Hue
1	91	-5%	-1%
2	92	-3%	3%
3	89	-1%	5%
4	94	0%	3%
5	94	0%	3%
6	95	3%	0%
7	94	-1%	-3%
8	98	-1%	-1%
9	95	-2%	2%
10	90	-2%	5%
11	88	1%	8%
12	91	6%	2%
13	93	3%	-3%
14	89	5%	-8%
15	90	0%	-7%
16	86	-1%	-11%

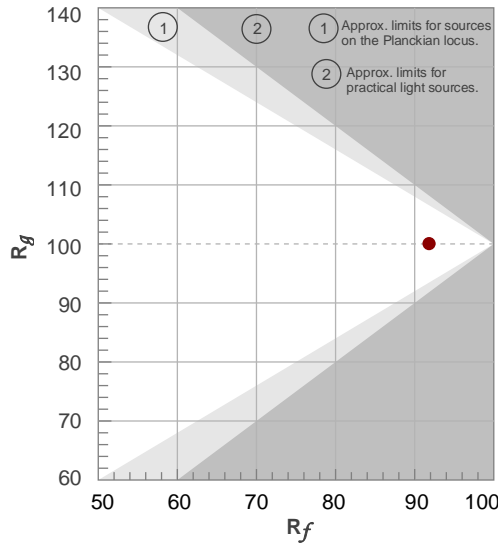

Color vector graphics

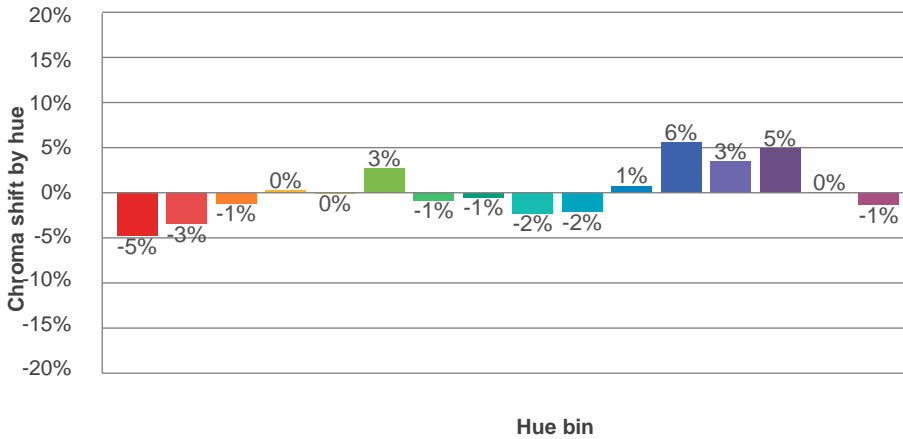
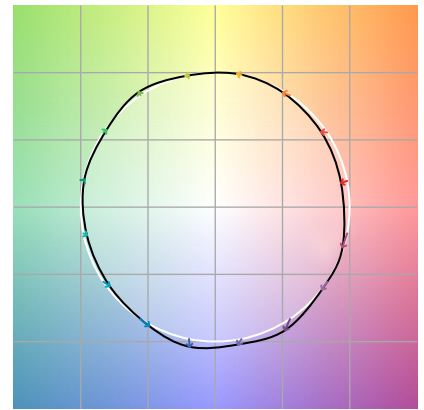

Color distortion

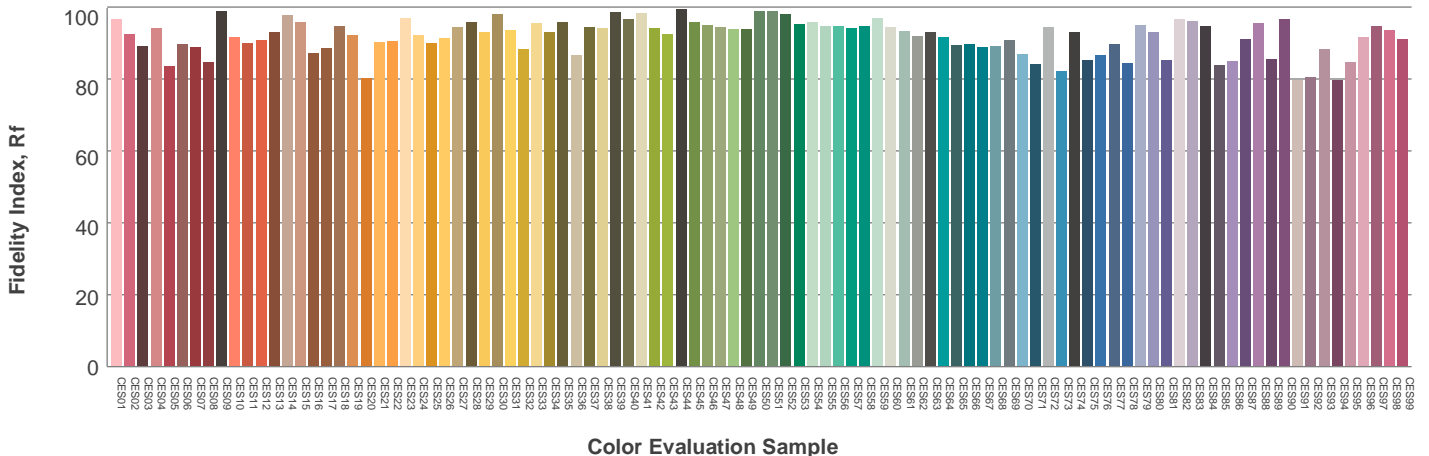

### Beam details

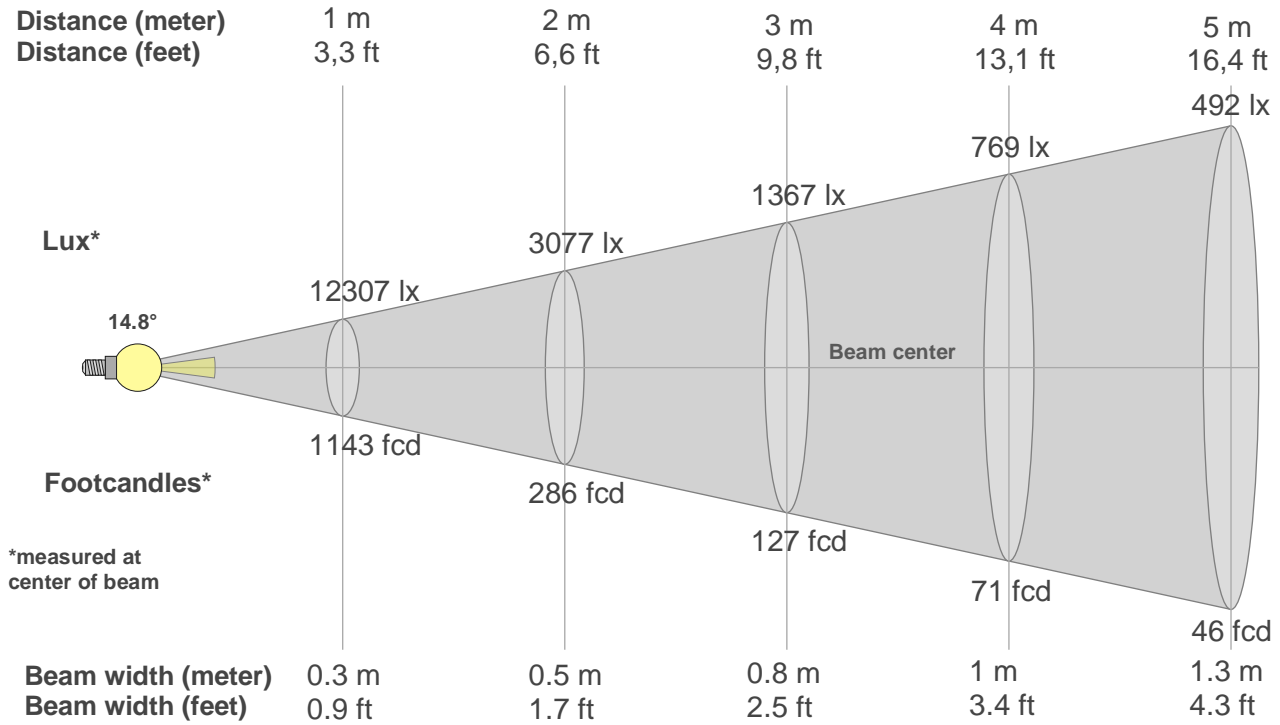

#### Beam intensities from 1-20m

1m	2m	3m	4m	5m	6m	7m	8m	9m	10m	11m	12m	13m	14m	15m	16m	17m	18m	19m	20m
3.3ft	6.6ft	9.8ft	13.1ft	16.4ft	19.7ft	23ft	26.2ft	29.5ft	32.8ft	36.1ft	39.4ft	42.7ft	45.9ft	49.2ft	52.5ft	55.8ft	59.1ft	62.3ft	65.6ft
12307lx	3077lx	1367lx	769lx	492lx	342lx	251lx	192lx	152lx	123lx	102lx	85lx	73lx	63lx	55lx	48lx	43lx	38lx	34lx	31lx
1143.3fcd	285.8fcd	127fcd	71.5fcd	45.7fcd	31.8fcd	23.3fcd	17.9fcd	14.1fcd	11.4fcd	9.4fcd	7.9fcd	6.8fcd	5.8fcd	5.1fcd	4.5fcd	4fcd	3.5fcd	3.2fcd	2.9fcd

#### Intensities in 0° c-plane

0°	1°	2°	3°	4°	5°	6°	7°	8°	9°	10°	11°	12°	13°	14°	15°	16°	17°	18°	19°
12.3K	12.2K	11.8K	11.1K	10.1K	9.1K	7.9K	6.6K	5.5K	4.5K	3.6K	2.9K	2.4K	2.0K	1.6K	1.3K	1.1K	0.8K	0.6K	0.4K
100%	99%	96%	90%	82%	74%	64%	54%	44%	36%	29%	24%	20%	16%	13%	11%	9%	7%	5%	3%

#### Intensities in 90° c-plane

0°	1°	2°	3°	4°	5°	6°	7°	8°	9°	10°	11°	12°	13°	14°	15°	16°	17°	18°	19°
12.3K	12.2K	11.8K	11.1K	10.1K	9.1K	7.9K	6.6K	5.5K	4.5K	3.6K	2.9K	2.4K	2.0K	1.6K	1.3K	1.1K	0.8K	0.6K	0.4K
100%	99%	96%	90%	82%	74%	64%	54%	44%	36%	29%	24%	20%	16%	13%	11%	9%	7%	5%	3%

#### Intensities in 180° c-plane

0°	1°	2°	3°	4°	5°	6°	7°	8°	9°	10°	11°	12°	13°	14°	15°	16°	17°	18°	19°
12.3K	12.2K	11.8K	11.1K	10.1K	9.1K	7.9K	6.6K	5.5K	4.5K	3.6K	2.9K	2.4K	2.0K	1.6K	1.3K	1.1K	0.8K	0.6K	0.4K
100%	99%	96%	90%	82%	74%	64%	54%	44%	36%	29%	24%	20%	16%	13%	11%	9%	7%	5%	3%

#### Intensities in 270° c-plane

0°	1°	2°	3°	4°	5°	6°	7°	8°	9°	10°	11°	12°	13°	14°	15°	16°	17°	18°	19°
12.3K	12.2K	11.8K	11.1K	10.1K	9.1K	7.9K	6.6K	5.5K	4.5K	3.6K	2.9K	2.4K	2.0K	1.6K	1.3K	1.1K	0.8K	0.6K	0.4K
100%	99%	96%	90%	82%	74%	64%	54%	44%	36%	29%	24%	20%	16%	13%	11%	9%	7%	5%	3%

Beam angle 50%	Field angle 10%	Cutoff angle 2,5%	Intensity ratio in 120° cone	Intensity ratio in 90° cone
14.8°	30.8°	39°	98.2%	97.9%

### Light planning

#### Luminaire budgetary diagram

LAMPS (number of lamps)  
50

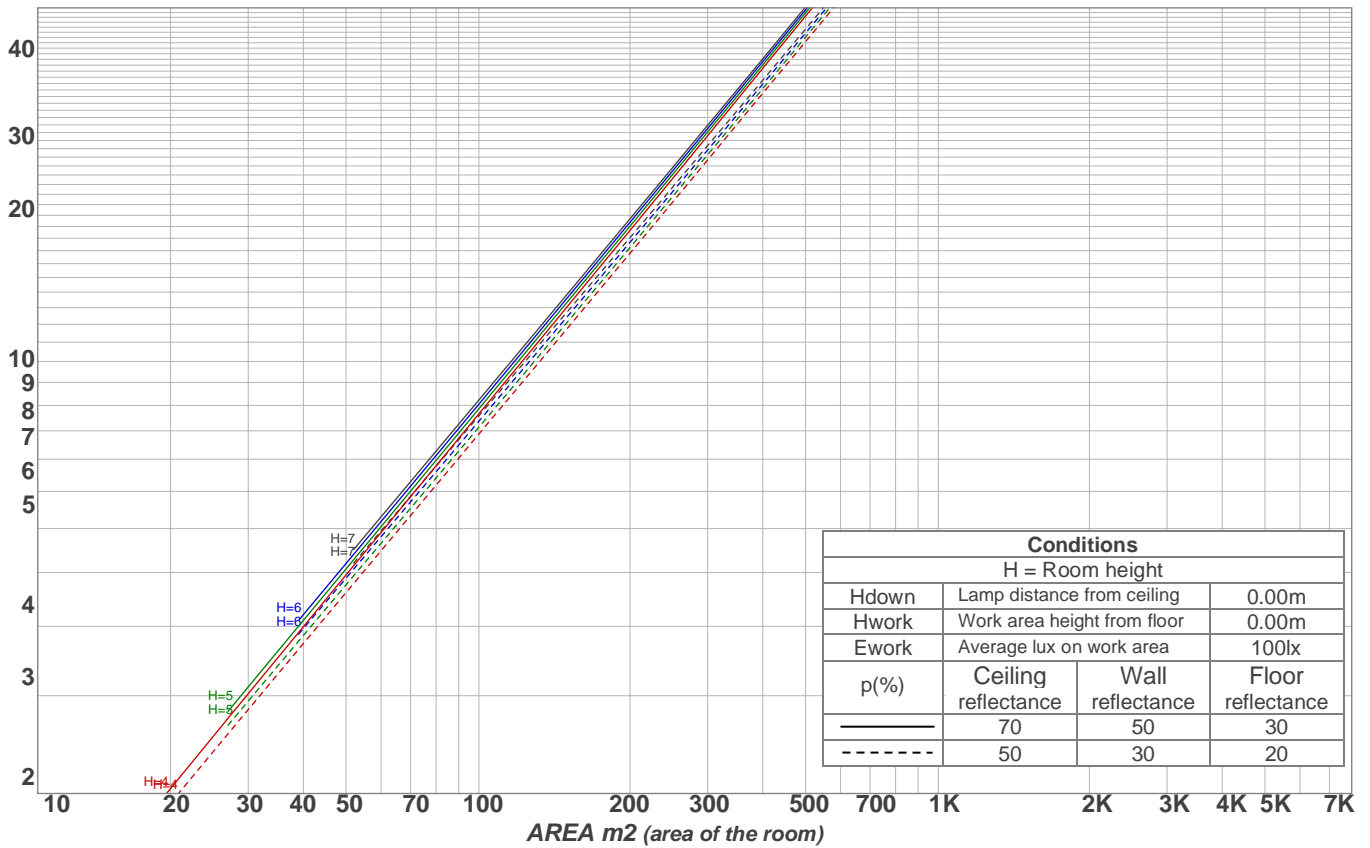

Luminaire budgetary diagram  
AREA m2 (area of the room)  
Coefficients of Utilization

Ceiling reflectance	80				70				50			30			10			0			
Wall reflectance	70	50	30	10	70	50	30	10	50	30	10	50	30	10	50	30	10	50	30	10	0
Floor reflectance	20	20	20	20	20	20	20	20	20	20	20	20	20	20	20	20	20	20	20	20	0
<b>RCR</b>	<b>(RCR: Room Cavity Ratio)</b>																				
	Room Values are expressed as percentage of Lumens delivered to the task surface																				
0	119	119	119	119	116	116	116	116	111	111	111	106	106	106	102	102	102	100	100	100	
1	115	113	112	110	113	111	110	108	107	106	105	104	103	102	100	100	99	97	97	97	
2	112	109	107	104	110	108	105	103	105	103	101	102	100	99	99	98	97	96	96	96	
3	110	106	103	100	108	105	102	99	102	100	98	100	98	97	98	96	95	94	94	94	
4	107	103	100	97	106	102	99	97	100	98	96	98	96	94	97	95	93	92	92	92	
5	105	100	97	95	104	100	97	94	98	96	93	97	94	93	95	94	92	91	91	91	
6	103	98	95	93	102	98	95	92	96	94	92	95	93	91	94	92	91	90	90	90	
7	101	96	93	91	101	96	93	91	95	92	90	94	92	90	93	91	89	89	89	89	
8	100	95	92	89	99	94	91	89	93	91	89	93	90	89	92	90	88	87	87	87	
9	98	93	90	88	98	93	90	88	92	89	88	91	89	87	91	89	87	86	86	86	
10	97	92	89	87	96	91	89	87	91	88	86	90	88	86	90	88	86	85	85	85	

Zonal Lumen Summary

0°-10°	10°-20°	20°-30°	30°-40°	40°-50°	50°-60°	60°-70°	70°-80°	80°-90°
672 lm	380 lm	13.5 lm	10.8 lm	3.00 lm	2.81 lm	4.42 lm	6.38 lm	6.40 lm
90°-100°	100°-110°	110°-120°	120°-130°	130°-140°	140°-150°	150°-160°	160°-170°	170°-180°
0.000 lm	0.000 lm	0.000 lm	0.000 lm	0.000 lm	0.000 lm	0.000 lm	0.000 lm	0.000 lm

UGR

p Ceiling		70	70	50	50	30	70	70	50	50	30
p Walls		50	30	50	30	30	50	30	50	30	30
p Floor		20	20	20	20	20	20	20	20	20	20
Room size X Y		Viewing direction at right angles to lamp axis					Viewing direction parallel to lamp axis				
2H	2H	14.8	15.0	14.8	15.2	15.4	14.8	15.0	14.8	15.2	15.4
	3H	18.6	19.1	19.0	19.3	19.4	18.6	19.1	19.0	19.3	19.4
	4H	21.2	21.6	21.5	21.9	22.1	21.2	21.6	21.5	21.9	22.1
	6H	24.2	24.6	24.5	24.9	25.2	24.2	24.6	24.5	24.9	25.2
	8H	25.9	26.2	26.2	26.6	26.9	25.9	26.2	26.2	26.6	26.9
	12H	27.7	28.0	28.0	28.4	28.8	27.7	28.0	28.0	28.4	28.8
4H	2H	15.8	16.3	16.2	16.5	16.7	15.8	16.3	16.2	16.5	16.7
	3H	20.2	20.6	20.6	20.9	21.3	20.2	20.6	20.6	20.9	21.3
	4H	22.8	23.2	23.2	23.6	24.1	22.8	23.2	23.2	23.6	24.1
	6H	25.9	26.4	26.4	26.7	27.0	25.9	26.4	26.4	26.7	27.0
	8H	27.6	28.0	28.2	28.4	28.7	27.6	28.0	28.2	28.4	28.7
	12H	29.5	29.8	30.0	30.2	30.7	29.5	29.8	30.0	30.2	30.7
8H	4H	24.0	24.3	24.5	24.7	25.0	24.0	24.3	24.5	24.7	25.0
	6H	27.3	27.5	27.8	28.0	28.5	27.3	27.5	27.8	28.0	28.5
	8H	29.2	29.4	29.7	29.9	30.5	29.2	29.4	29.7	29.9	30.5
	12H	31.2	31.4	31.8	31.9	32.5	31.2	31.4	31.8	31.9	32.5
12H	4H	24.3	24.6	24.8	25.0	25.5	24.3	24.6	24.8	25.0	25.5
	6H	27.8	28.0	28.3	28.5	29.1	27.8	28.0	28.3	28.5	29.1
	8H	29.7	29.9	30.3	30.4	31.0	29.7	29.9	30.3	30.4	31.0
Corrected glare indices referring to 1099 lm total luminous flux											