

The Yashar Family

Welcome to the Yashar Family of track and track accent lights. The pendant Yashar Low Voltage 48 volt track offered in two profiles is field cuttable and available in white or black painted finishes with a variety of canopy and suspension options available. The pendant track is single circuit with DALI control options for multi-zone configurations or 0-10V control for single zone dimming. The remote power supplies are available in a several wattages and can be powered at 120 or 277 volts. The Yashar Low Voltage version of track is also available for surface mount and recessed applications. In addition to the low voltage version, Yashar Mains offers a 120/277 volt track solution with their own compatible track heads. You have found the Yashar Low Voltage Surface Mounted track. We hope that you enjoy the details.

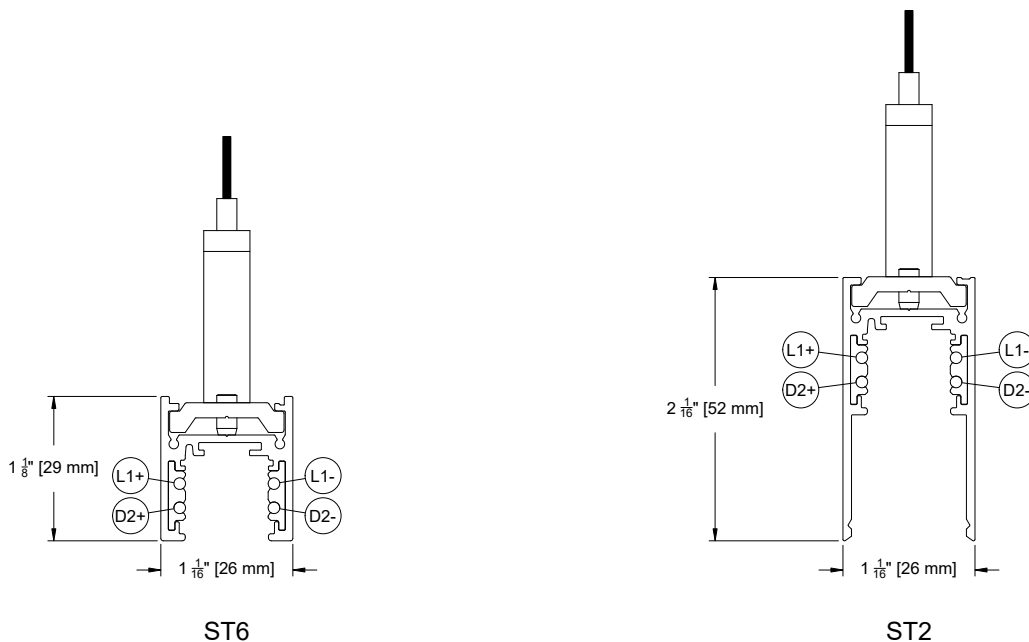
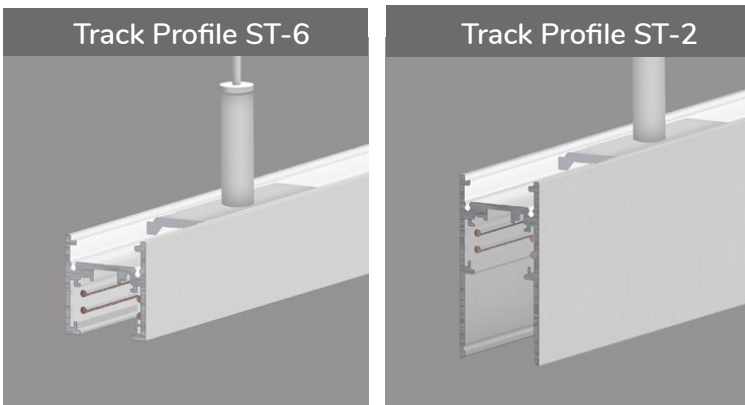

PROJECT:

TYPE:

SPECIFIER:

DATE:

Key Points (YSLT-P)

Housing

- Extruded aluminum pendant mounted multi circuit track is available in two profiles with standard lengths of 4 foot (1200cm) and 8 foot (2400cm) and field cuttable to custom lengths.
- Available with a variety of suspension types and canopy styles.
- Track system components include end caps, end and joiner feeds, straight joiners, corner joiners, T joiners, and X joiners.
- Available in black or white painted finishes..

Electrical and Dimming Configurations

- 48 Volt track is furnished in a single circuit configuration, dimmable via DALI or 0-10V controls using the second pair of conductors to carry data (DALI) or the 0-10V signal. DALI control allows control of individual fixtures on the track, allowing for multiple control zones on a single track. The 0-10V dimming controls all fixtures on the track as a single control zone.

Power Supplies

- Remote 48 volt DC power supplies are Universal (120/277V) on the supply side and available in 40, 60, 100, 150, 185 and 240 watts. For other wattages consult factory

Pendant Mounted Track Configuration ST6 Profile

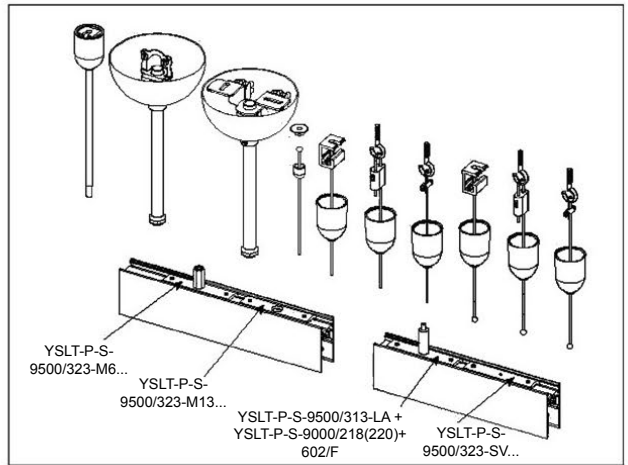
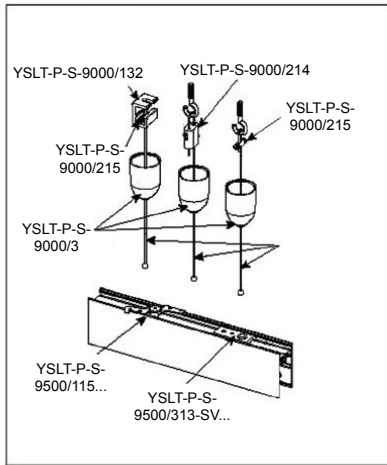
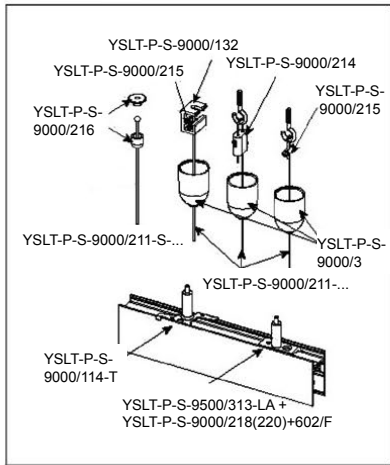
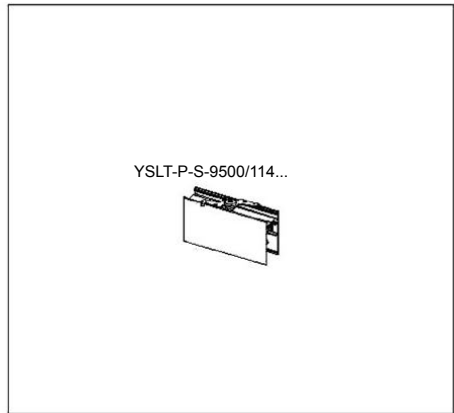
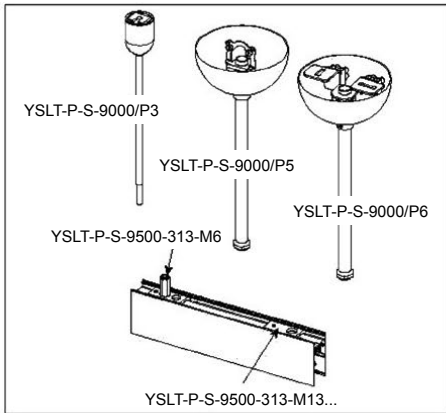
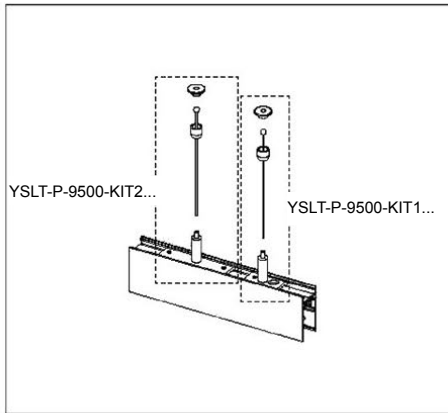
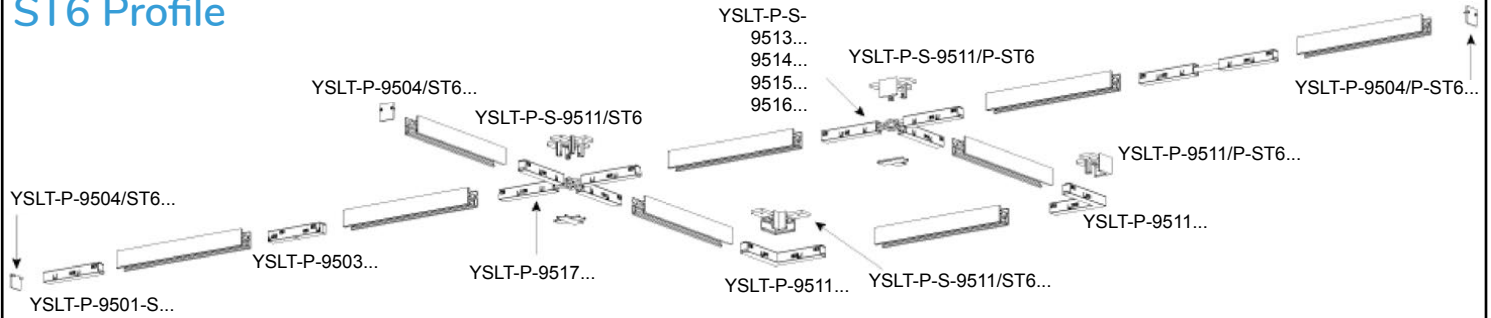

Ordering Code Example for a pendant mounted T configuration, black track with 12 foot long X 4 foot long legs suspended from aircraft cable with a 240 watt remote 48 Volt power supply:

- (2) YSLT-P-9500-UL8/B-ST6-E
(8 foot long track to be field cut to 6 foot lengths)
- (1) YSLT-P-9500-UL4/B-ST6-E
(4 foot long track to be field cut to 3 foot length)
- (1) YSLT-P-9501-S/B-E
(End feed)
- (1) YSLT-P-9514-K/B-E
(T connector)

- (1) YSLT-P-S-9511/T-P-ST6
(T connector cover/joiner)
- (3) YSLT-P-9504/ST6-B
(End caps)
- (5) YSLT-P-9500-KIT1-1.5
(Suspension Kits with steel cable)
- (1) YSLT-P-S-RE-P-B
(Black supply suspension kit)

- (1) YSLT-P-RPS-240
(240 watt remote 48V power supply)

Pendant Mounted Track Configuration ST2 Profile

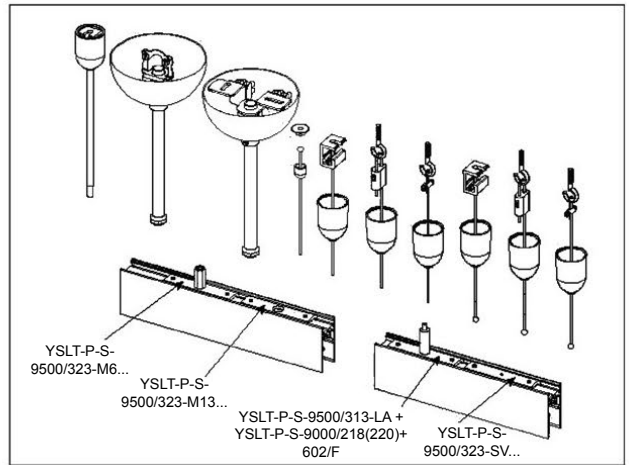
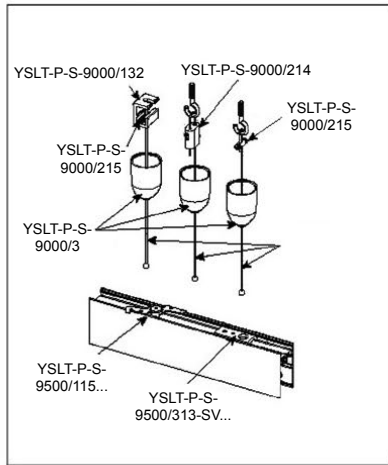
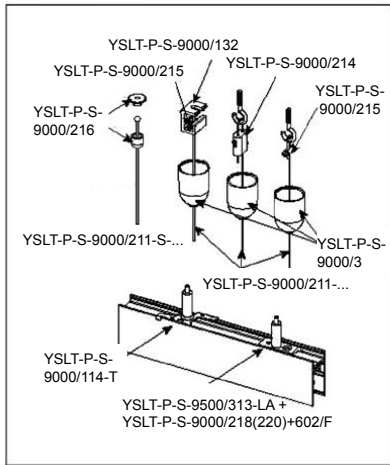
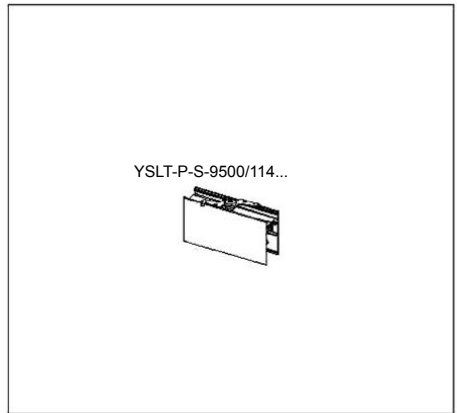
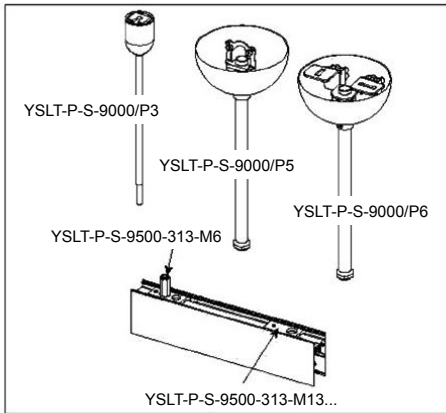
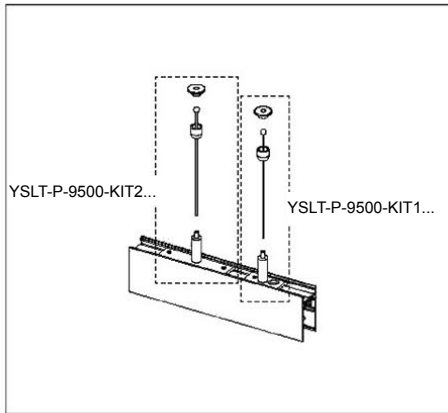
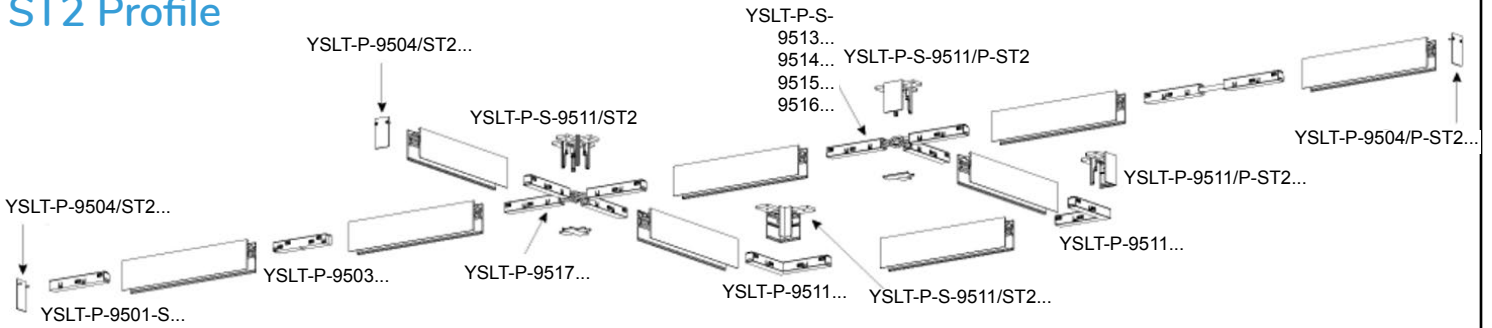





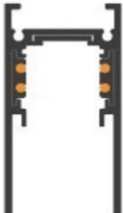
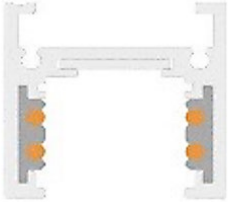

Ordering Code Example for pendant mounted L configuration, white track with 7 foot by 3 foot long legs , suspended 20" with a 100 watt remote 48 Volt power supply:







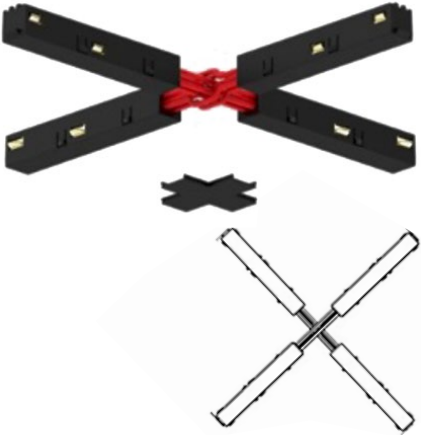

- | | |
|---|--|
| (1) YSLT-P-9500-UL8/W2-ST1-E
(8 foot long track to be field cut to 6 foot lengths) | (2) YSLT-P-S-9504/ST1-W
(End caps) |
| (1) YSLT-P-9500-UL4/W2-ST1-E
(4 foot long track to be field cut to 3 foot length) | (3) YSLT-P-9500-KIT1-1.5
(Suspension Kits with steel cable) |
| (1) YSLT-P-9501-S/W-E
(End feed) | (1) YSLT-P-S-RE-P-W2
(White supply suspension kit) |
| (1) YSLT-P-9511/W-E
(L-corner connector) | (1) YSLT-P-RPS-100
(100 watt remote 48V power supply) |

PART#		DESCRIPTION
YASHAR PENDANT	48V TRACK ST2	
	YSLT-P-9500-UL4/W2-ST2-E	White painted trimless EVO track 4 ft
	YSLT-P-9500-UL8/W2-ST2-E	White painted double emission embossed EVO track 8 ft
	YSLT-P-9500-UL4/B-ST2-E	Black anodized and black painted double emission embossed EVO track 4 ft
	YSLT-P-9500-UL8/B-ST2-E	Black anodized and black painted double emission embossed EVO track 8 ft
YASHAR PENDANT	48V TRACK ST6	
	YSLT-P-9500-UL4/W2-ST6-E	White painted embossed EVO track 4 ft
	YSLT-P-9500-UL8/W2-ST6-E	White painted embossed EVO track 8 ft
	YSLT-P-9500-UL4/B-ST6-E	Black anodized and black painted embossed EVO track 4 ft
	YSLT-P-9500-UL8/B-ST6-E	Black anodized and black painted embossed EVO track 8 ft





ELECTRO-MECHANICAL CONNECTIONS		
END FEED		
	YSLT-P-9501-S/W-E	White short end feed
	YSLT-P-9501-S/B-E	Black short end feed
	YSLT-P-9501-S-KL/W-E	White short end feed polarized left
	YSLT-P-9501-S-KL/B-E	Black short end feed polarized left
	YSLT-P-9501-S-KR/W-E	White short end feed polarized right
	YSLT-P-9501-S-KR/B-E	Black short end feed polarized right
MIDDLE FEED		
	YSLT-P-9503-S/W-E	White short middle feed
	YSLT-P-9503-S/B-E	Black short middle feed
	YSLT-P-9503-S/W-M-E	White mechanical short middle feed
	YSLT-P-9503-S/B-M-E	Black mechanical short middle feed
	YSLT-P-9503-S-K/W-E	White short middle feed polarized
	YSLT-P-9503-S-K/B-E	Black short middle feed polarized



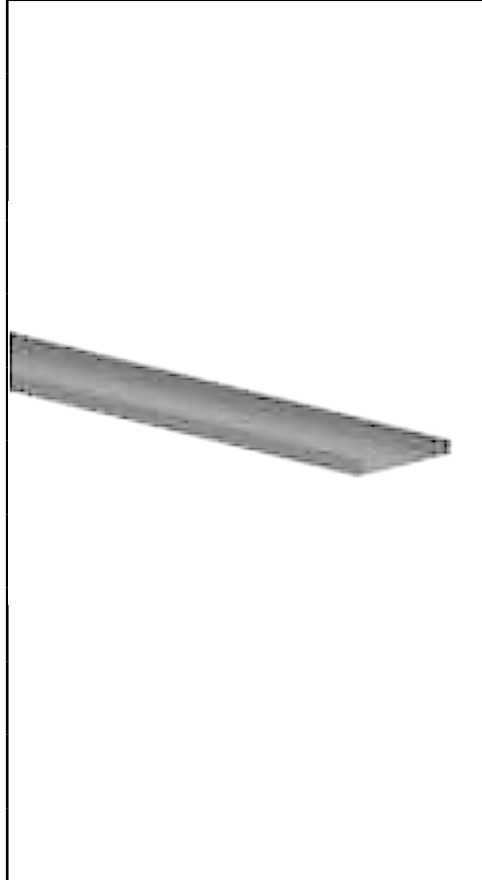

PART#		DESCRIPTION
L-FEED		
	YSLT-P-9511/W-E	White L feed
	YSLT-P-9511/B-E	Black L feed
	YSLT-P-9511-KE/W-E	White L feed polarized external
	YSLT-P-9511-KE/B-E	Black L feed polarized external
	YSLT-P-9511-KI/W-E	White L feed polarized internal
	YSLT-P-9511-KI/B-E	Black L feed polarized internal
ADJUSTABLE CORNER		
	YSLT-P-9518-S/W-E	White adjustable corner
	YSLT-P-9518-S/B-E	Black adjustable corner
	YSLT-P-9518-S-K/W-E	White adjustable corner polarized
	YSLT-P-9518-S-K/B-E	Black adjustable corner polarized
T- FEED		
	YSLT-P-9513/B-E	Black T Electrical Connector
	YSLT-P-9513/W-E	White T Electrical Connector
	YSLT-P-9513-K/B-E	Black T Electrical Polarized Connector
	YSLT-P-9513-K/W-E	White T Electrical Polarized Connector
	YSLT-P-9514-K/B-E	Black T Electrical Polarized Connector
	YSLT-P-9514-K/W-E	White T Electrical Polarized Connector
	YSLT-P-9515-K/B-E	Black T Electrical Polarized Connector
	YSLT-P-9515-K/W-E	White T Electrical Polarized Connector
	YSLT-P-9516-K/B-E	Black T Electrical Polarized Connector
	YSLT-P-9516-K/W-E	White T Electrical Polarized Connector

PART#	DESCRIPTION	
X- FEED		
	YSLT-P-9517/B-E	Black X-Electrical Connector
	YSLT-P-9517/W-E	White X-Electrical Connector
	YSLT-P-9517-K/B-E	Black X-Electrical Connector Polarized
	YSLT-P-9517-K/W-E	White X-Electrical Connector Polarized
REMOTE 48 VOLT POWER SUPPLIES		
	YSLT-P-RPS-40	Universal (120/277V) 40 watt 48 volt power supply
	YSLT-P-RPS-60	Universal (120/277V) 60 watt 48 volt power supply
	YSLT-P-RPS-100	Universal (120/277V) 100 watt 48 volt power supply
	YSLT-P-RPS-150	Universal (120/277V) 150 watt 48 volt power supply
	YSLT-P-RPS-185	Universal (120/277V) 185 watt 48 volt power supply
	YSLT-P-RPS-240	Universal (120/277V) 240 watt 48 volt power supply





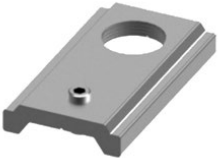

PART#		DESCRIPTION
END CAP		
	YSLT-P-9504/ST2-W	White end cap for track ST2 and ST5 with locking screws (not mounted)
	YSLT-P-9504/ST2-B	Black end cap for track ST2 and ST5 with locking screws (not mounted)
	YSLT-P-9504/ST2-W-F	White end cap for track ST2 with locking screws (not mounted) with central hole and gasket for cable
	YSLT-P-9504/ST2-B-F	Black end cap for track ST2 with locking screws (not mounted) with central hole and gasket for cable
	YSLT-P-9504/ST6-W	White end cap for track ST6 with locking screws (not mounted)
	YSLT-P-9504/ST6-B	Black end cap for track ST6 with locking screws (not mounted)
	YSLT-P-9504/ST6-W-F	White end cap for track ST6 with locking screws (not mounted) with central hole and gasket for cable
	YSLT-P-9504/ST6-B-F	Black end cap for track ST6 with locking screws (not mounted) with central hole and gasket for cable
	YSLT-P-9504/ST2-P-W2	White plastic end cap for track ST2 with locking screws (not mounted)
	YSLT-P-9504/ST2-P-B	Black plastic end cap for track ST2 with locking screws (not mounted)
	YSLT-P-9504/ST2-P-W2-F	White plastic end cap for track ST2 with locking screws (not mounted) with central hole for cable
	YSLT-P-9504/ST2-P-B-F	Black plastic end cap for track ST2 with locking screws (not mounted) with central hole for cable
	YSLT-P-9504/ST6-P-W2	White plastic end cap for track ST6 with locking screws (not mounted)
	YSLT-P-9504/ST6-P-B	Black plastic end cap for track ST6 with locking screws (not mounted)
	YSLT-P-9504/ST6-P-W2-F	White plastic end cap for track ST6 with locking screws (not mounted) with central hole for cable
	YSLT-P-9504/ST6-P-B-F	Black plastic end cap for track ST6 with locking screws (not mounted) with central hole for cable

PART#	DESCRIPTION	
TRACK ACCESSORIES		
COVER STRIP FOR THE TRACK		
	YSLT-P- S-9500-L/B-UL4	Black (not painted) cover strip L= 4 ft
	YSLT-P- S-9500-L/B-UL8	Black (not painted) cover strip L= 8ft
	YSLT-P- S-9500-LE/B-UL8	Black aesthetic cover (not painted) cover strip L=8Ft
	YSLT-P- S-9500-LE/B-UL4	Black aesthetic cover (not painted) cover strip L=4Ft
	YSLT-P- S-9500-LE/W2-UL8	White RAL9016 aesthetic cover (not painted) cover strip L=8Ft
	YSLT-P- S-9500-LE/W2-UL4	White RAL9016 aesthetic cover (not painted) cover strip L=4Ft
	YSLT-P- S-9500/SE-F-UL4	Smoked Aesthetic Cover Strip L=4Ft
	YSLT-P- S-9500/SE-F-UL8	Smoked Aesthetic Cover Strip L=8Ft
	YSLT-P- S-9500/SE-OPN-UL4	Opal Aesthetic Cover Strip L=4Ft
	YSLT-P- S-9500/SE-OPN-UL8	Opal Aesthetic Cover Strip L=8Ft
	YSLT-P- S-9500/MIC-UL4	Prismatic Optic
	YSLT-P- S-9500/MIC-UL8	Prismatic Optic
	YSLT-P- S-9500/OPN-UL4	Opal Optic TL=56%
	YSLT-P- S-9500/OPN-UL8	Opal Optic TL=56%
	YSLT-P- S-9500/TR-UL4	Transparent Optic TL=90%
	YSLT-P- S-9500/TR-UL8	Transparent Optic TL=90%

PART#	DESCRIPTION	
PENDANT ACCESSORIES		
COMPLETE SUSPENSION KITS		
	YSLT-P-9500-KIT1-1.5	Round head ceiling attachment/Steel cable 1.5mm dia L=1.5m/Bracket with automatic gripper
	YSLT-P-9500-KIT1-3	Round head ceiling attachment/Steel cable 1.5mm dia L=3m/Bracket with automatic gripper
	YSLT-P-9500-KIT1-5	Round head ceiling attachment/Steel cable 1.5mm dia L=5m/Bracket with automatic gripper
	YSLT-P-9500-KIT2-1.5	Round head ceiling attachment/Steel cable 1.5mm dia L=1.5m/Bracket with automatic gripper
	YSLT-P-9500-KIT2-3	Round head ceiling attachment/Steel cable 1.5mm dia L=3m/Bracket with automatic gripper
	YSLT-P-9500-KIT2-5	Round head ceiling attachment/Steel cable 1.5mm dia L=5m/Bracket with automatic gripper
	YSLT-P-S-9000-P3-W	Ceiling bracket + M6 nut + white plastic cup + M6 threaded bar (length 1 m) with cover strip
	YSLT-P-S-9000-P3-B	Ceiling bracket + M6 nut + black plastic cup + M6 threaded bar (length 1 m) with cover strip
	YSLT-P-S-9000-P6-S-B	Black suspension set
	YSLT-P-S-9000-P6-S-W2	White suspension set
	YSLT-P-S-9000-P5-W2	White suspension set
	YSLT-P-S-9000-P5-B	Black suspension set

PART#	DESCRIPTION	
SINGLE PENDANT ACCESSORIES		
PLASTIC CUPS		
	YSLT-P-S-9000/3-W	White plastic cup for steel cable diameter 1,5 mm
	YSLT-P-S-9000/3-B	Black plastic cup for steel cable diameter 1,5 mm
ROUND HEAD		
	YSLT-P-S-9000/216	Round head ceiling attachment
CEILING BRACKET FOR SUSPENSIONS		
	YSLT-P-S-9000/132	Ceiling bracket for suspensions
FAST FIXING CLAMP		
	YSLT-P-S-9500/114-T-B	Black painted track fast fixing clamp with gripper
	YSLT-P-S-9500/114-T-W2	White painted track fast fixing clamp with gripper
CLAMP		
	YSLT-P-S-9000/118-W	White painted fast fixing clamp with M6 threaded gripper
	YSLT-P-S-9000/118-B	Black painted fast fixing clamp with M6 threaded gripper

PART#	DESCRIPTION	
SINGLE PENDANT ACCESSORIES		
SHORT PENDANT BRACKET		
	YSLT-P-S-9500/312-LA-W	White short pendant bracket with countersunk hole for suspensions
	YSLT-P-S-9500/312-LA-B	Black short pendant bracket with countersunk hole for suspensions
ROUND HEAD		
	YSLT-P-S-9500/312-SV-W	White short pendant bracket for suspensions
	YSLT-P-S-9500/312-SV-B	Black short pendant bracket for suspensions
CEILING BRACKET FOR SUSPENSIONS		
	YSLT-P-S-9500/313-LA	Short pendant bracket with countersunk hole for suspensions
	YSLT-P-S-9500/313-SV	Short pendant bracket for suspensions
FAST FIXING CLAMP		
	YSLT-P-S-9500/313-M13	Short pendant bracket for suspensions
CLAMP		
	YSLT-P-S-9500/313-M6	Short pendant bracket for suspensions

PART#	DESCRIPTION	
SINGLE PENDANT ACCESSORIES		
LONG PENDANT BRACKET		
	YSLT-P-S-9500/322-LA-W	White long pendant bracket with countersunk hole for suspensions
	YSLT-P-S-9500/322-LA-B	Black long pendant bracket with countersunk hole for suspensions
	YSLT-P-S-9500/322-SV-W	White long pendant bracket for suspensions
	YSLT-P-S-9500/322-SV-B	Black long pendant bracket for suspensions
	YSLT-P-S-9500/323-LA	Long pendant bracket with countersunk hole for suspensions
	YSLT-P-S-9500/323-SV	Long pendant bracket for suspensions
	YSLT-P-S-9500/323-M13	Long pendant bracket for suspensions
	YSLT-P-S-9500/323-M6	Long pendant bracket for suspensions

PART#	DESCRIPTION	
CONNECTION ACCESSORIES		
COVERS FOR CONNECTORS		
	YSLT-P-S-9511/W-ST2	White cover for L joint for ST2 track
	YSLT-P-S-9511/B-ST2	Black cover for L joint for ST2 track
	YSLT-P-S-9511/W-ST6	White cover for L joint for ST6 track
	YSLT-P-S-9511/B-ST6	Black cover for L joint for ST6 track
	YSLT-P-S-9511/316-LA	L bracket for angles
	YSLT-P-S-RE-P-B	Black supply/suspension box kit
	YSLT-P-S-RE-P-W2	White supply/suspension box kit
	YSLT-P-S-9513/T-P-ST2	Track Joiner T
	YSLT-P-S-9517/X-P-ST2	Track Joiner X